

LOT II

Centre de formation agro-sylvo-pastoral et halieutique à Toroli

LOGEMENT DES PROFESSEURS

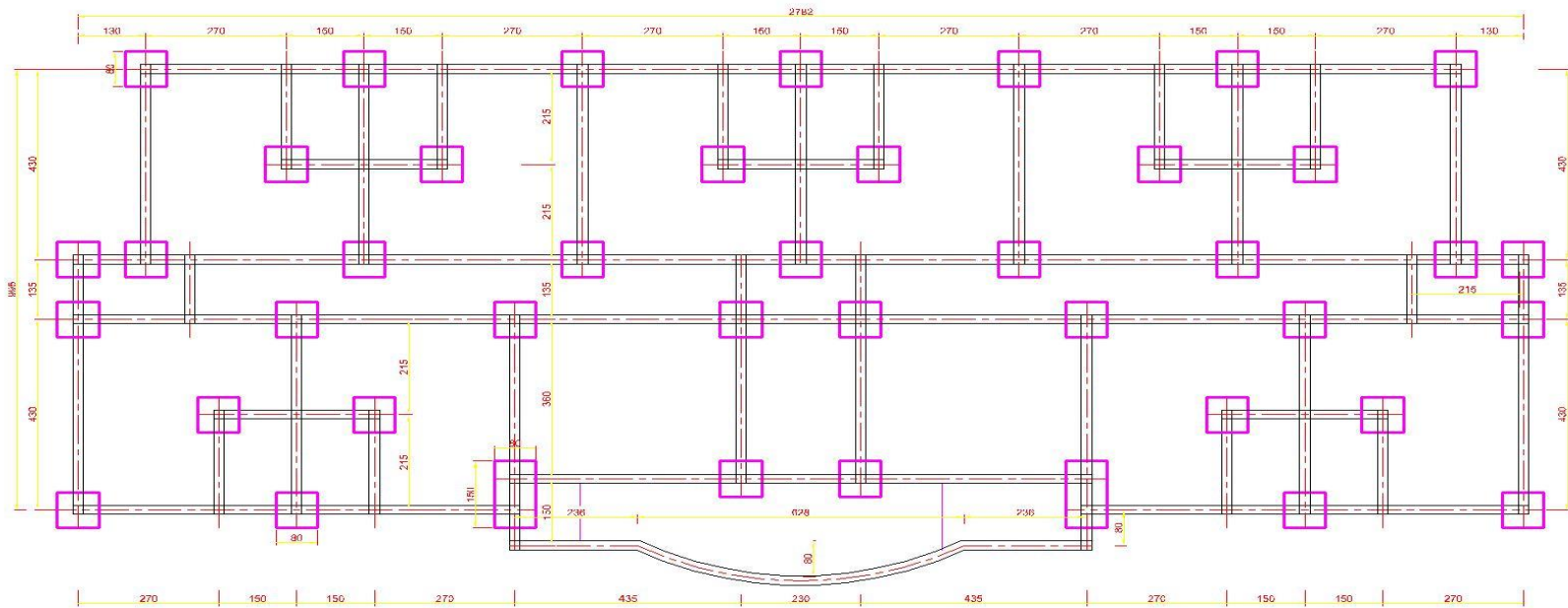

FONDATION

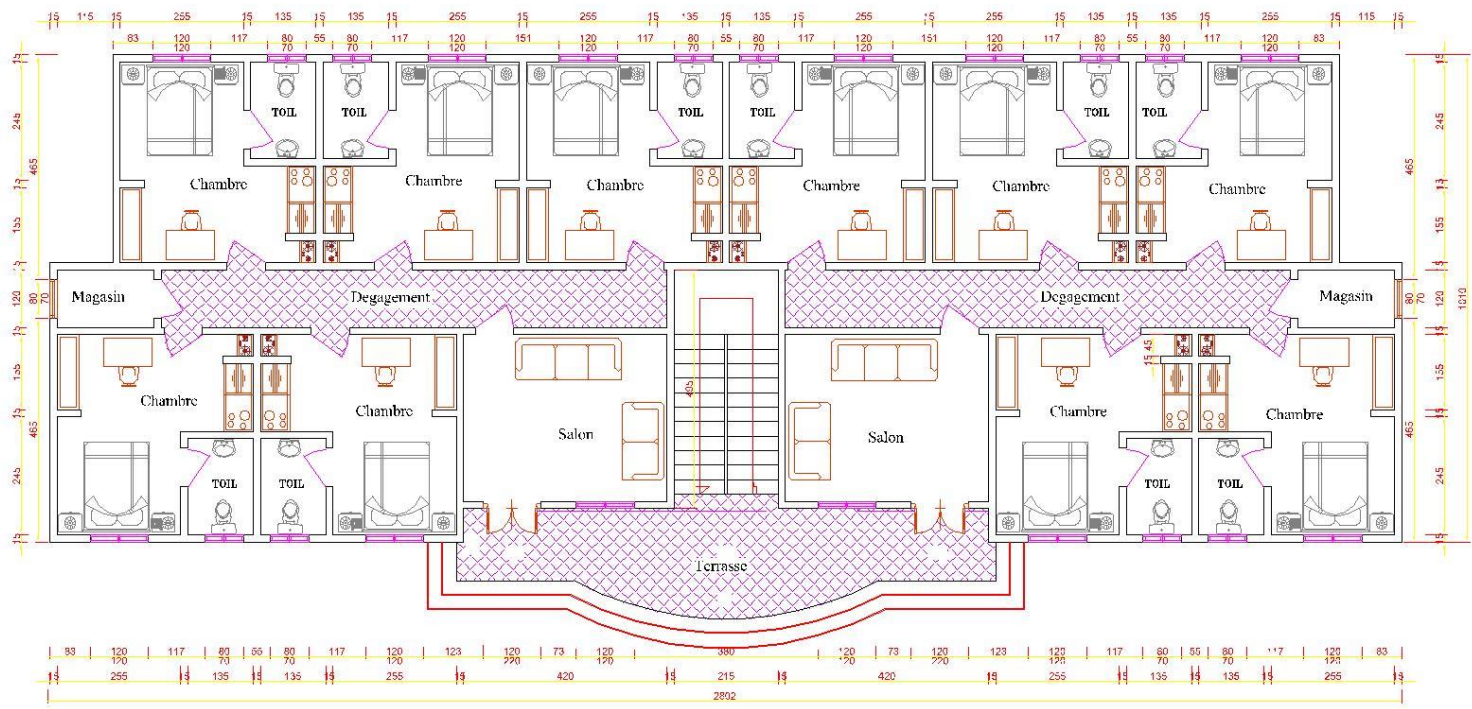

PLAN RDC

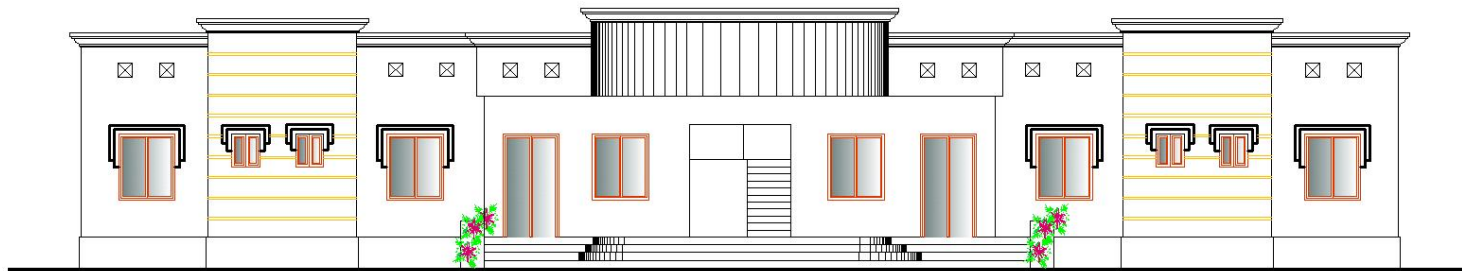

FAÇADE PRINCIPALE

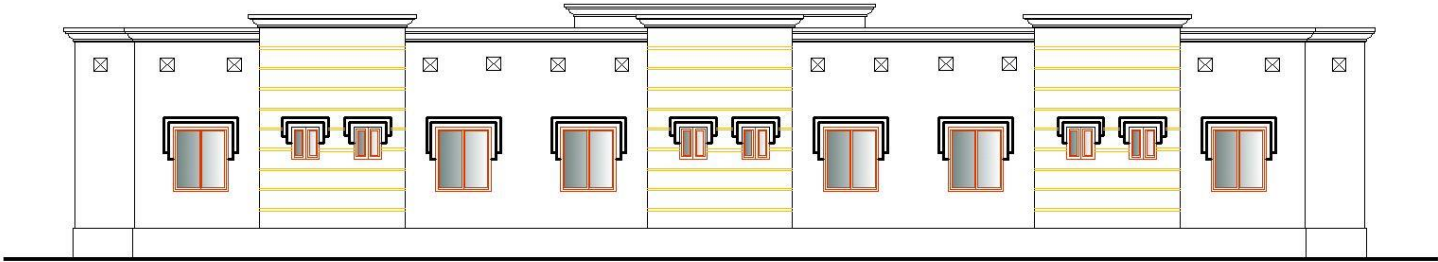

FAÇADE POSTERIEUR

DORTOIR DES ETUDIANTS

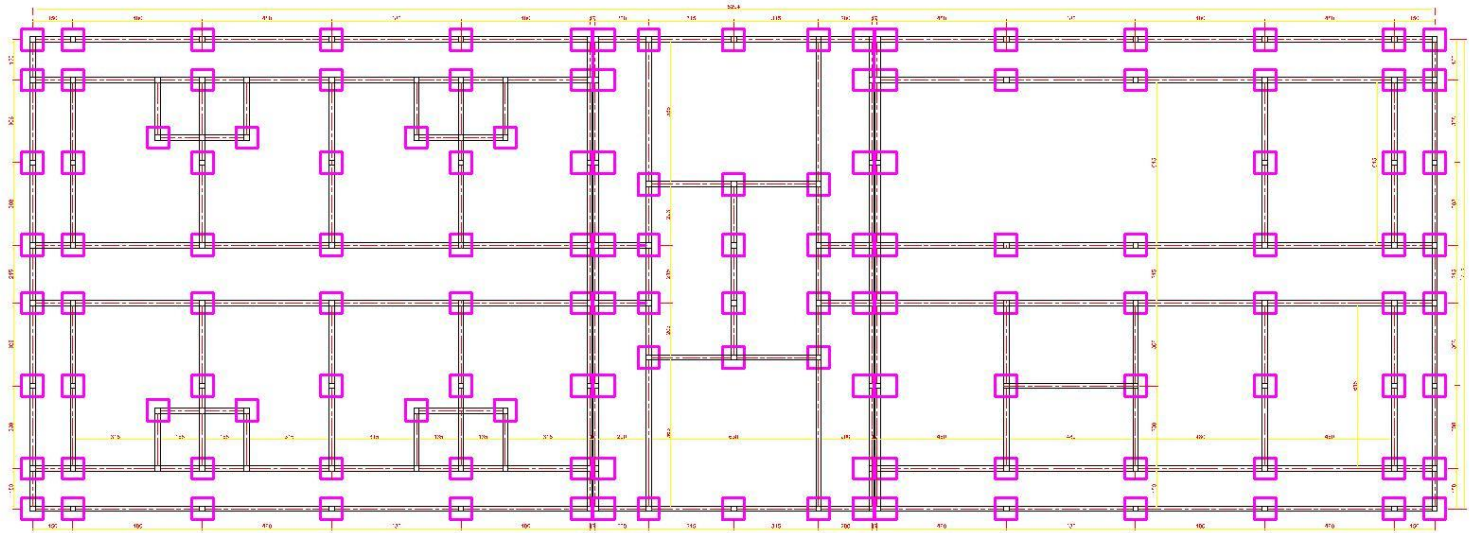

FONDATION



RDC

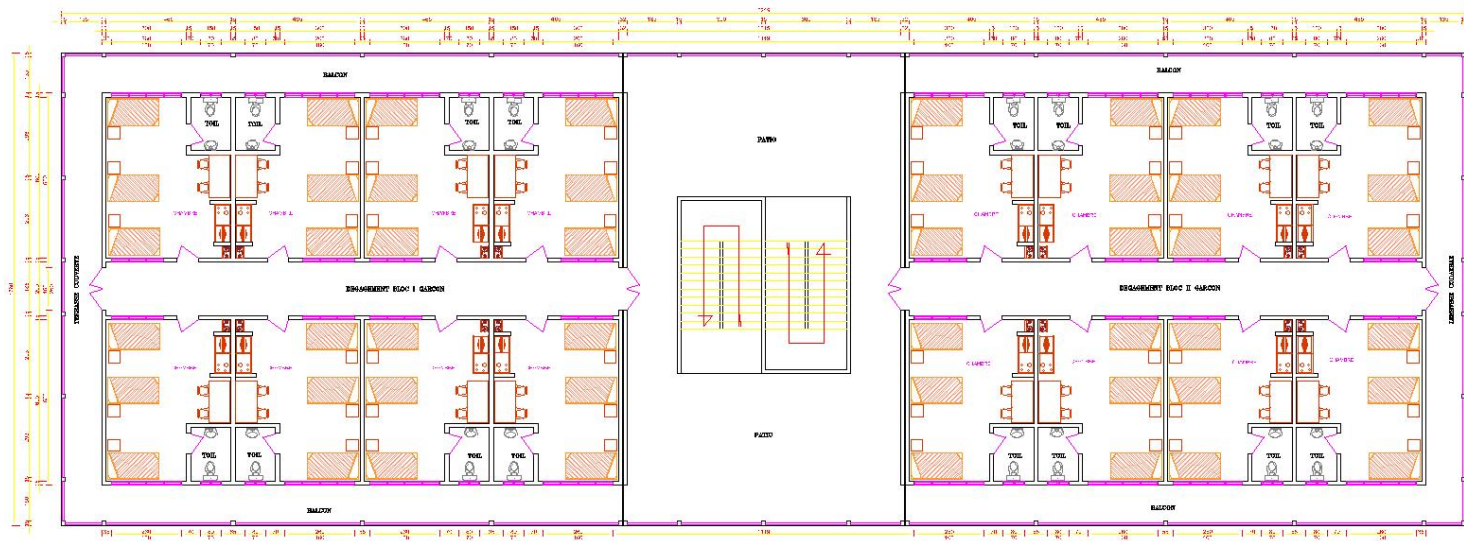

ETAGE



FAÇADE PRINCIPALE



FAÇADE POSTERIEURE

BLOC PEDAGOGIQUE

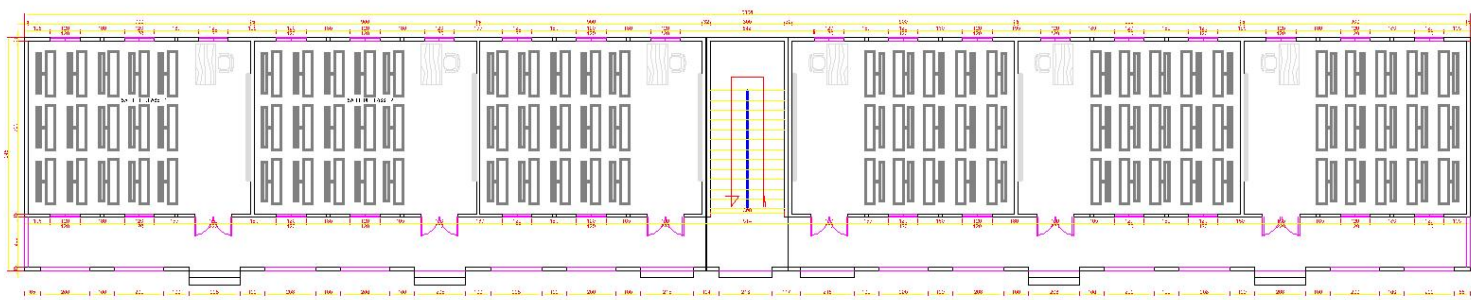

001 P L A N

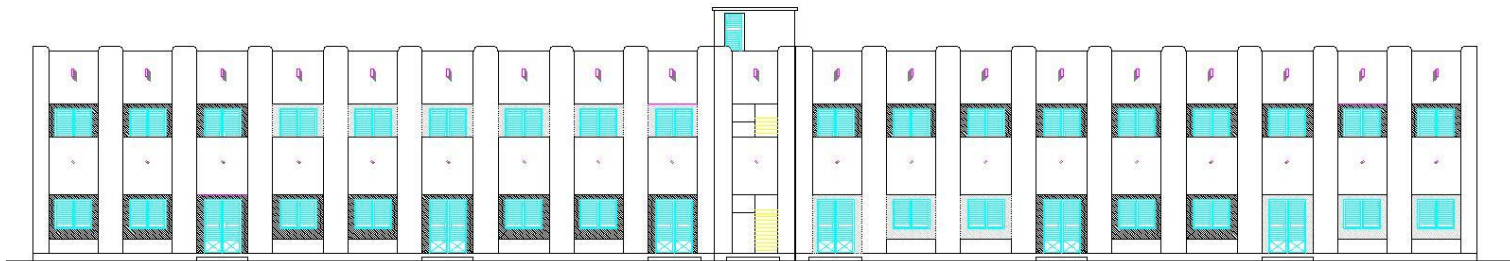

18. DEL PLANI 1/100

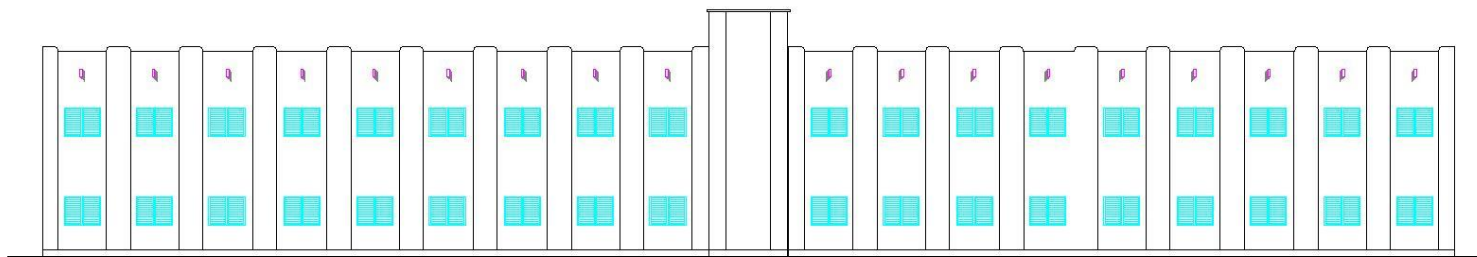
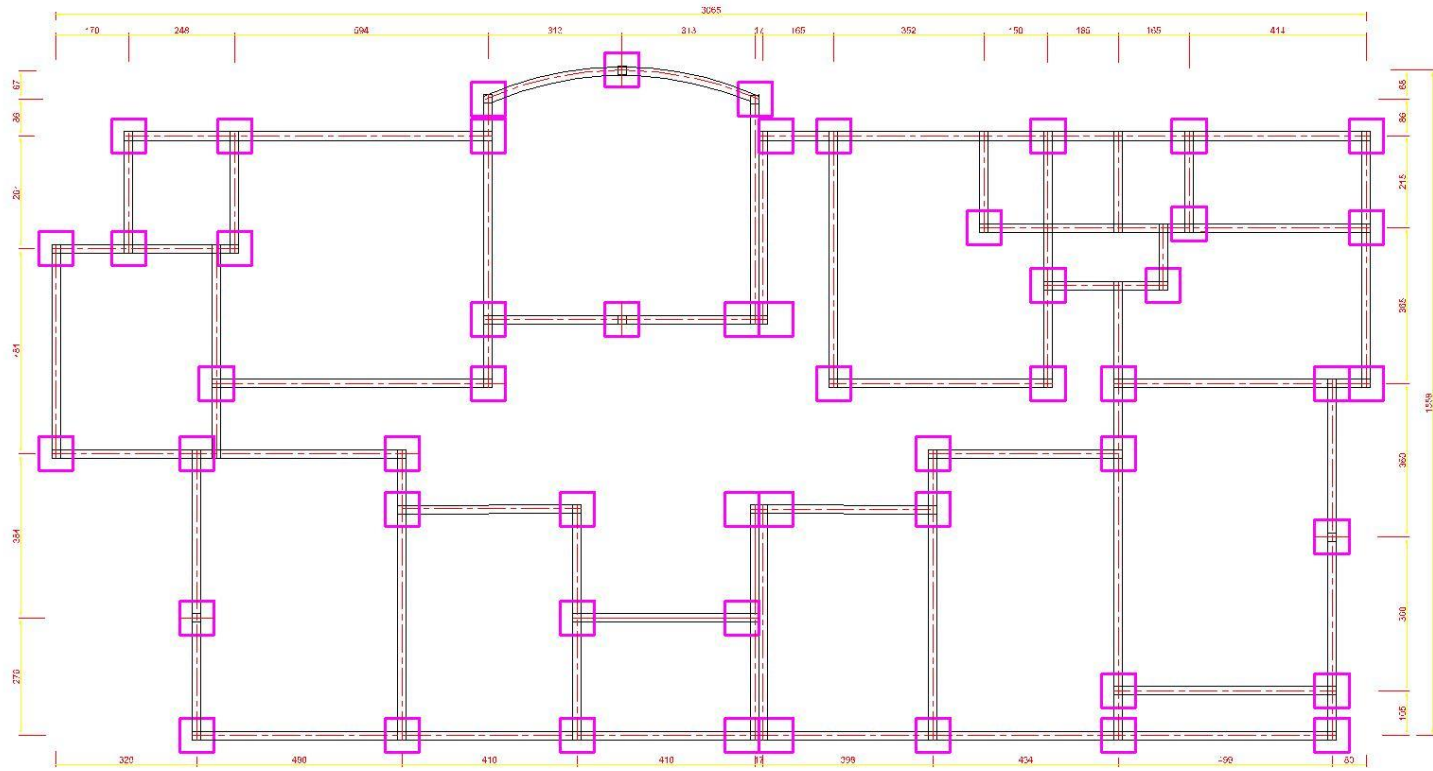
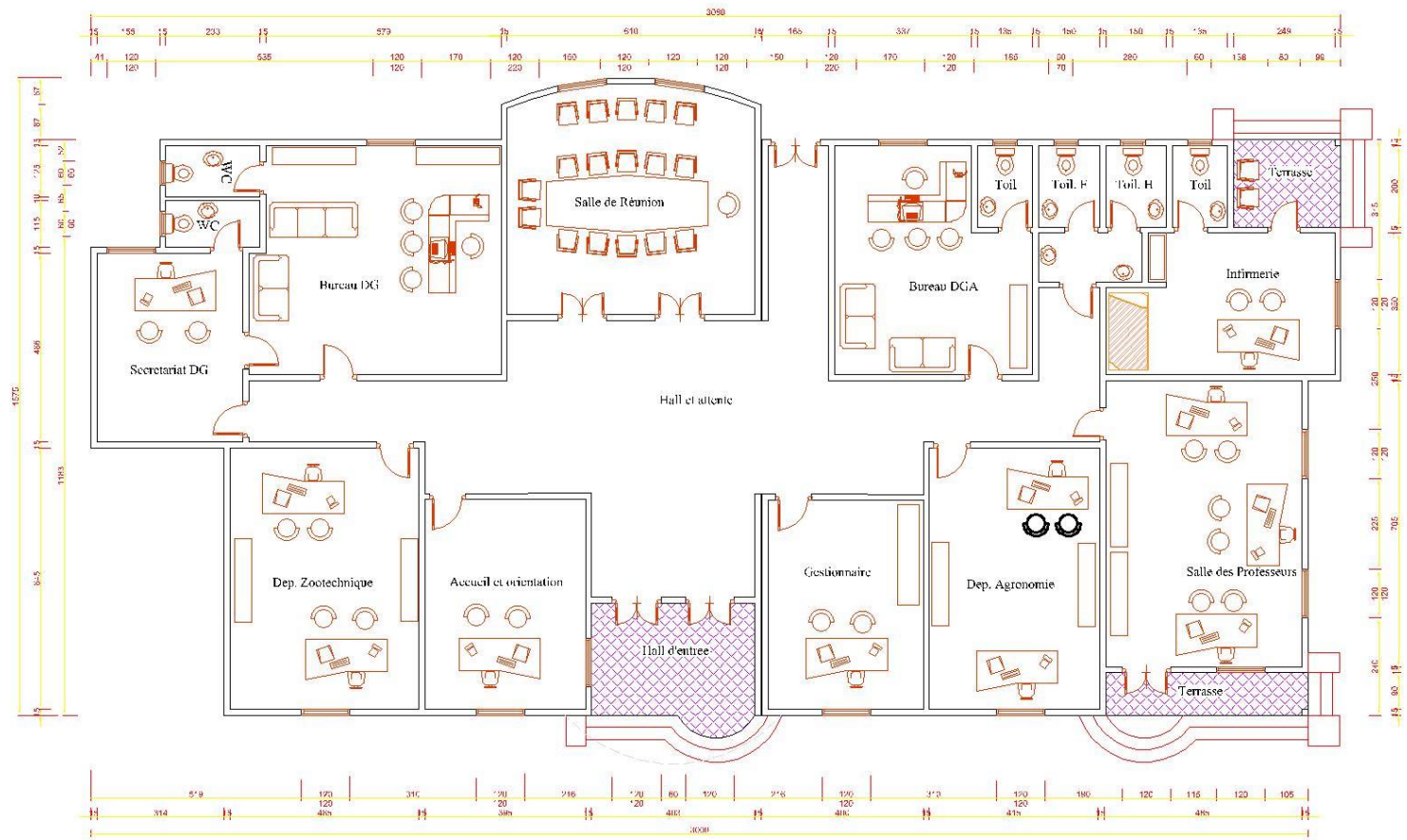

Figure 108-10

BLOC ADMINISTRATIF



FONDATION



VUE EN PLAN

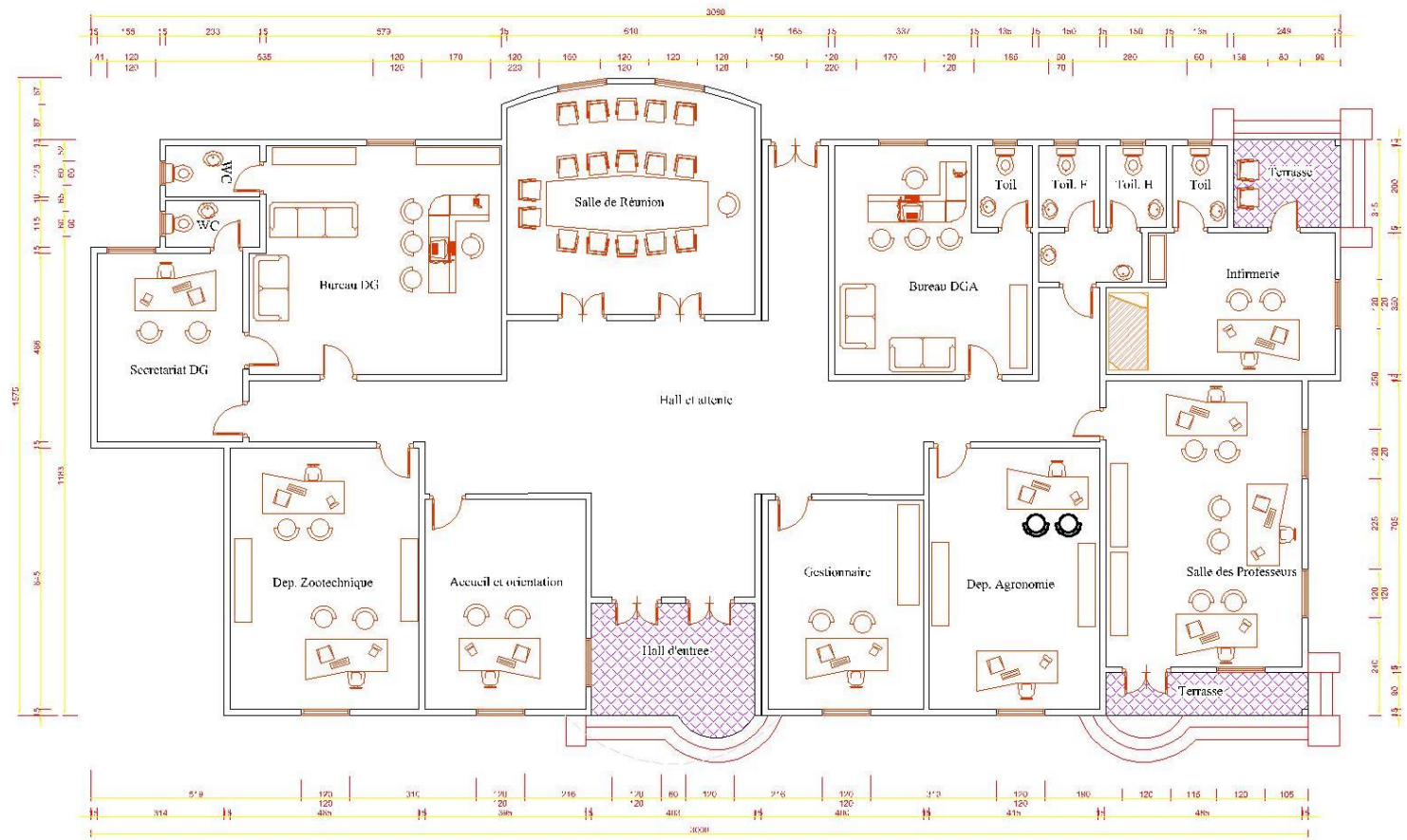

VUE EN PLAN

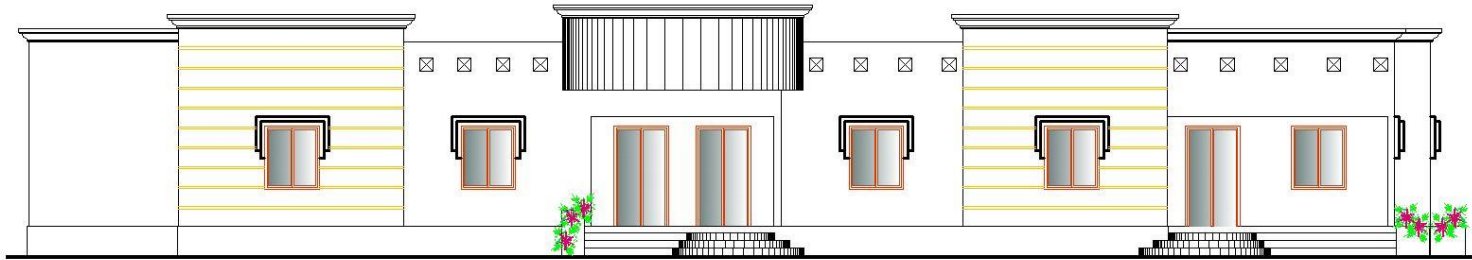

FAÇADE PRINCIPALE

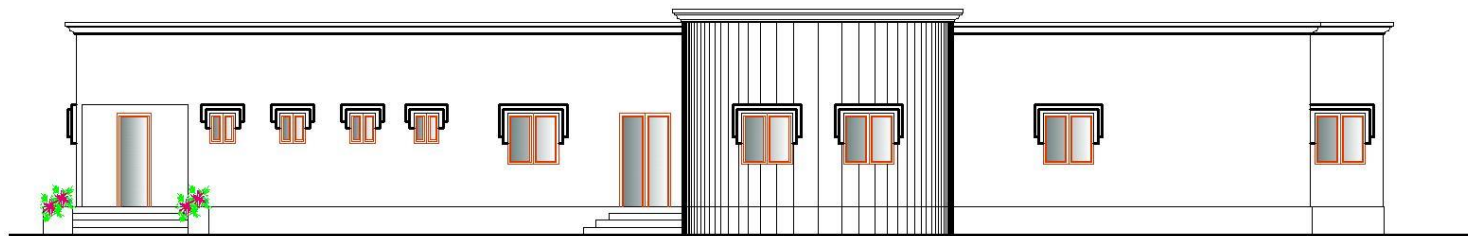

FAÇADE POSTERIEUR

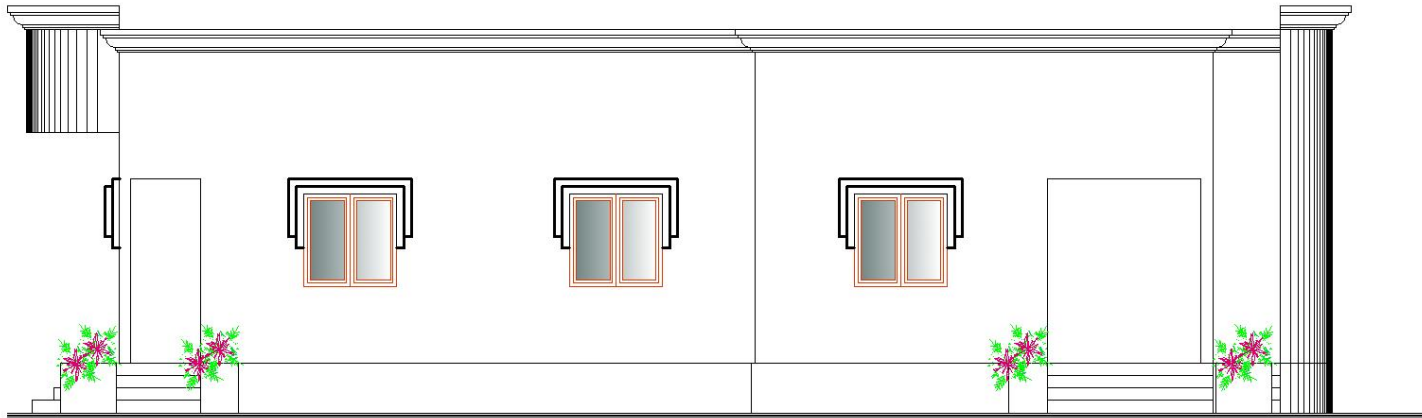

FAÇADE LATÉRALE DROITE

BLOC LABORATOIRE

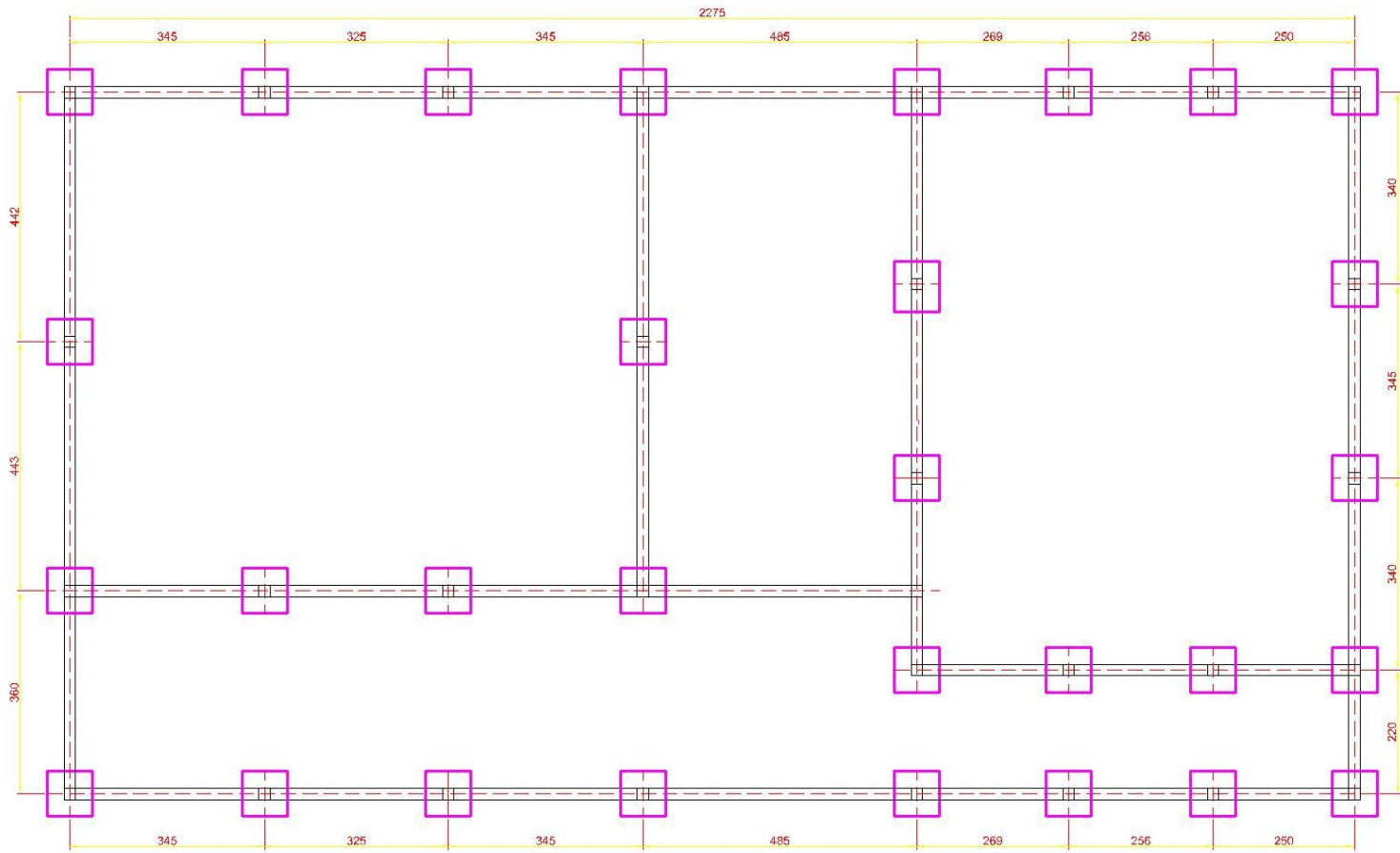

FONDATION

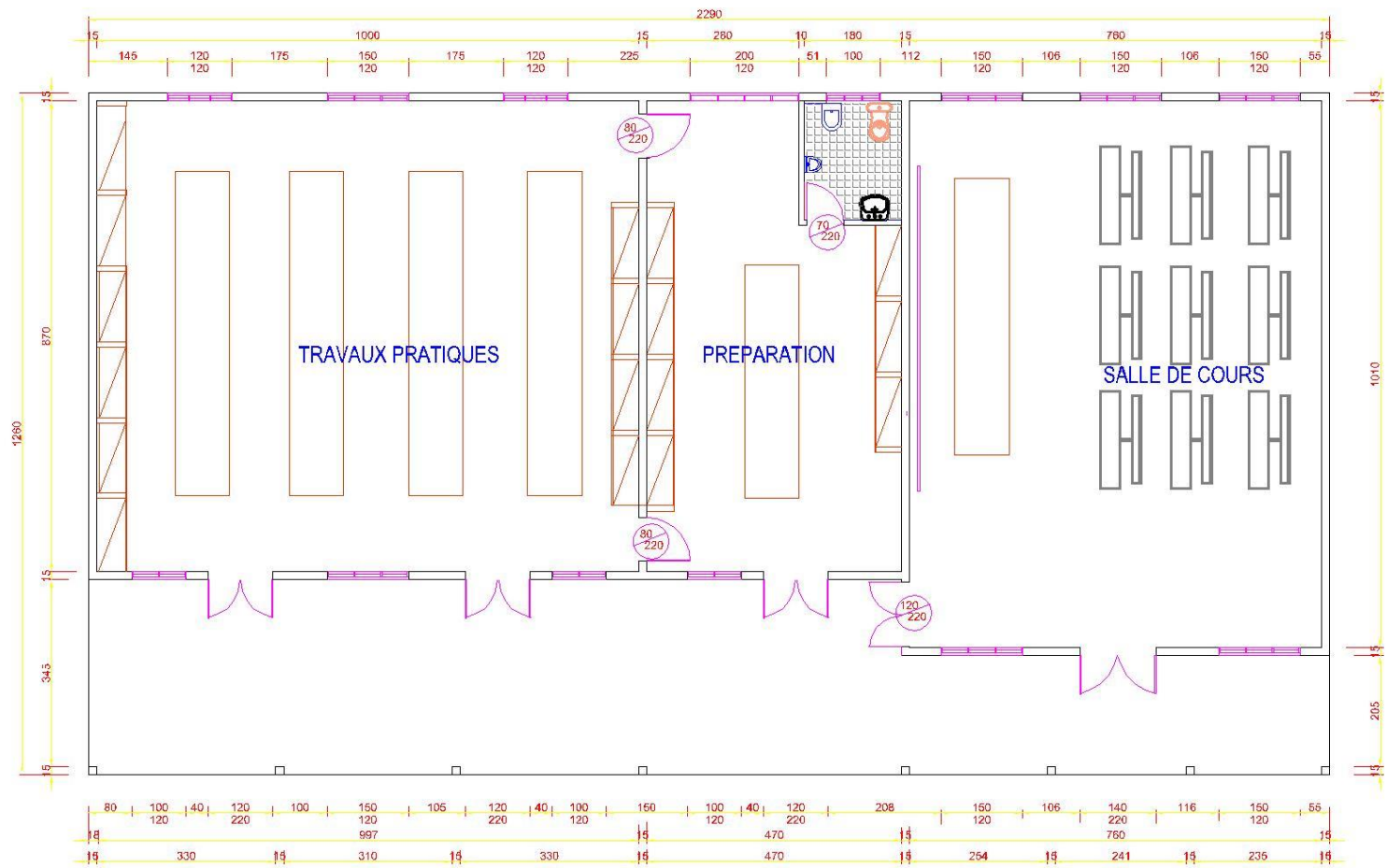

VUE EN PLAN

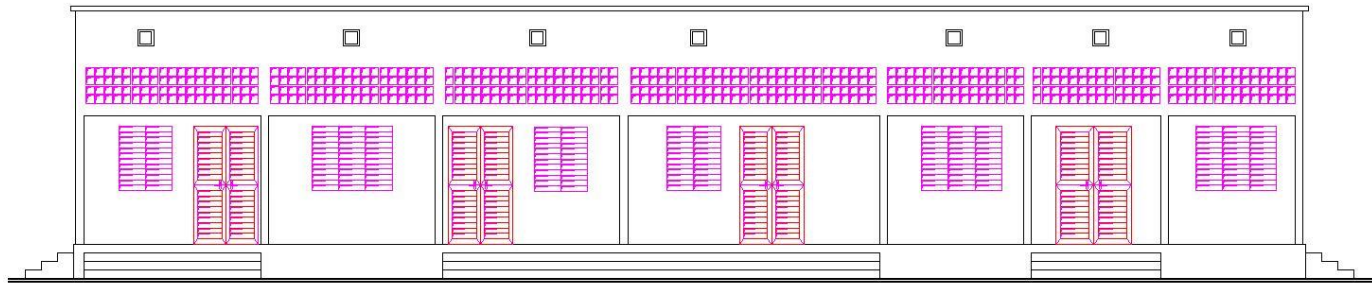

FAÇADE PRINCIPALE

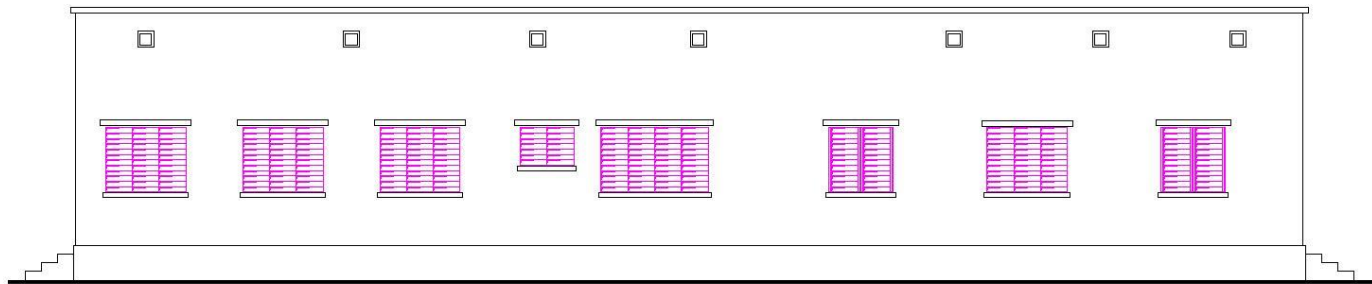

FAÇADE POSTERIEURE

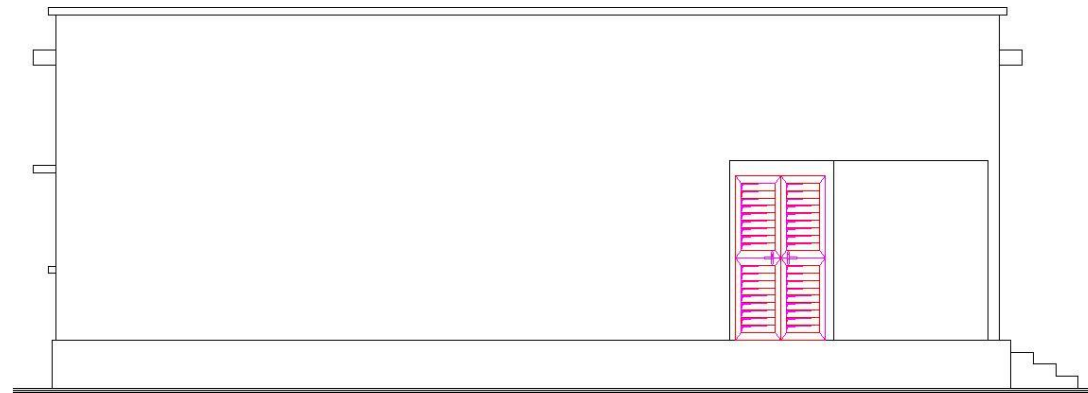

FAÇADE.LAT.GAUCHE

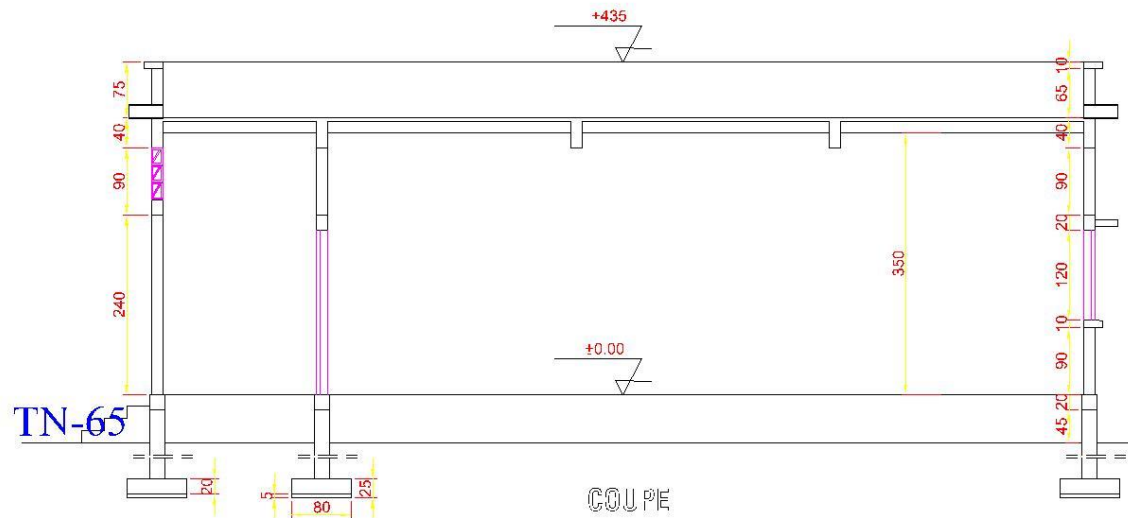

LOGEMENT DG ET DGA

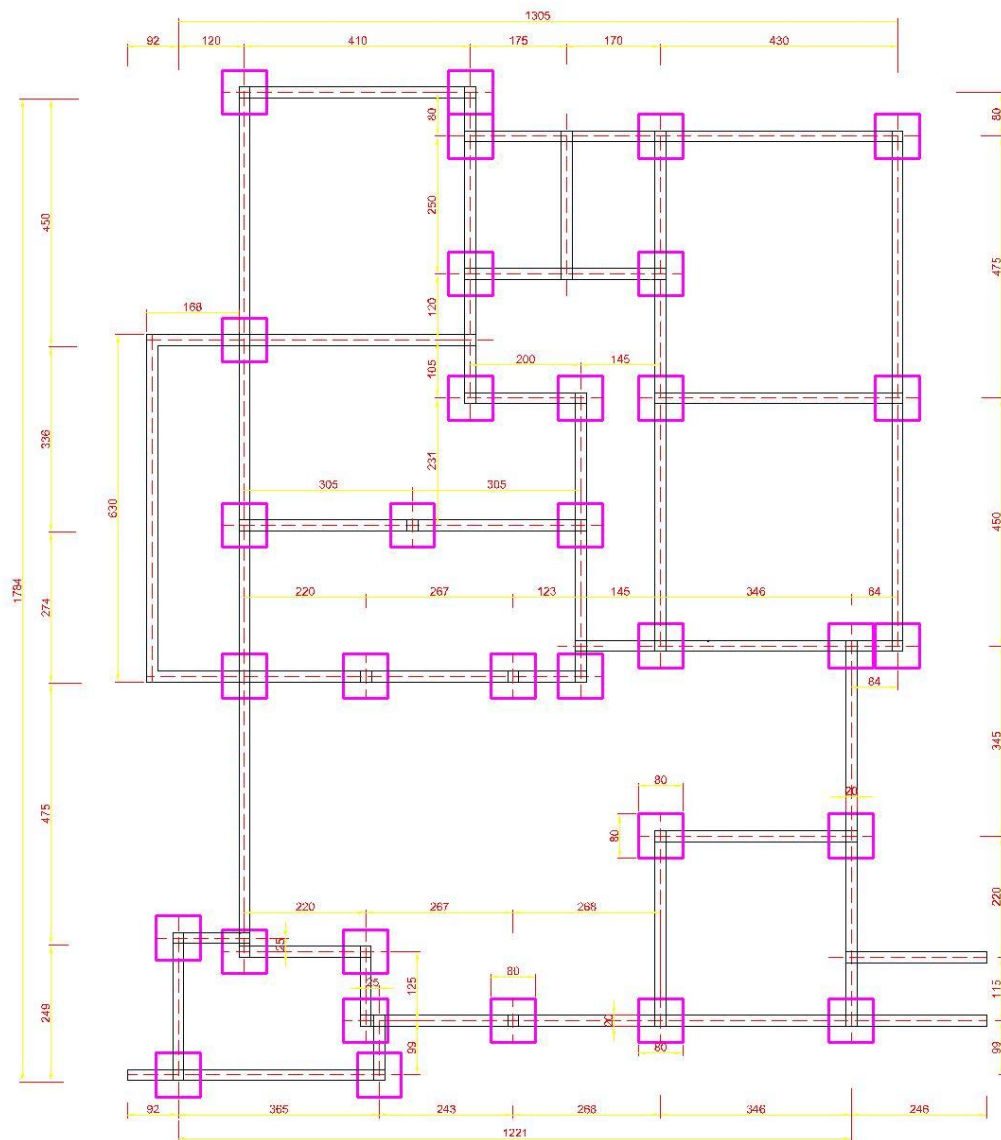

FONDATION

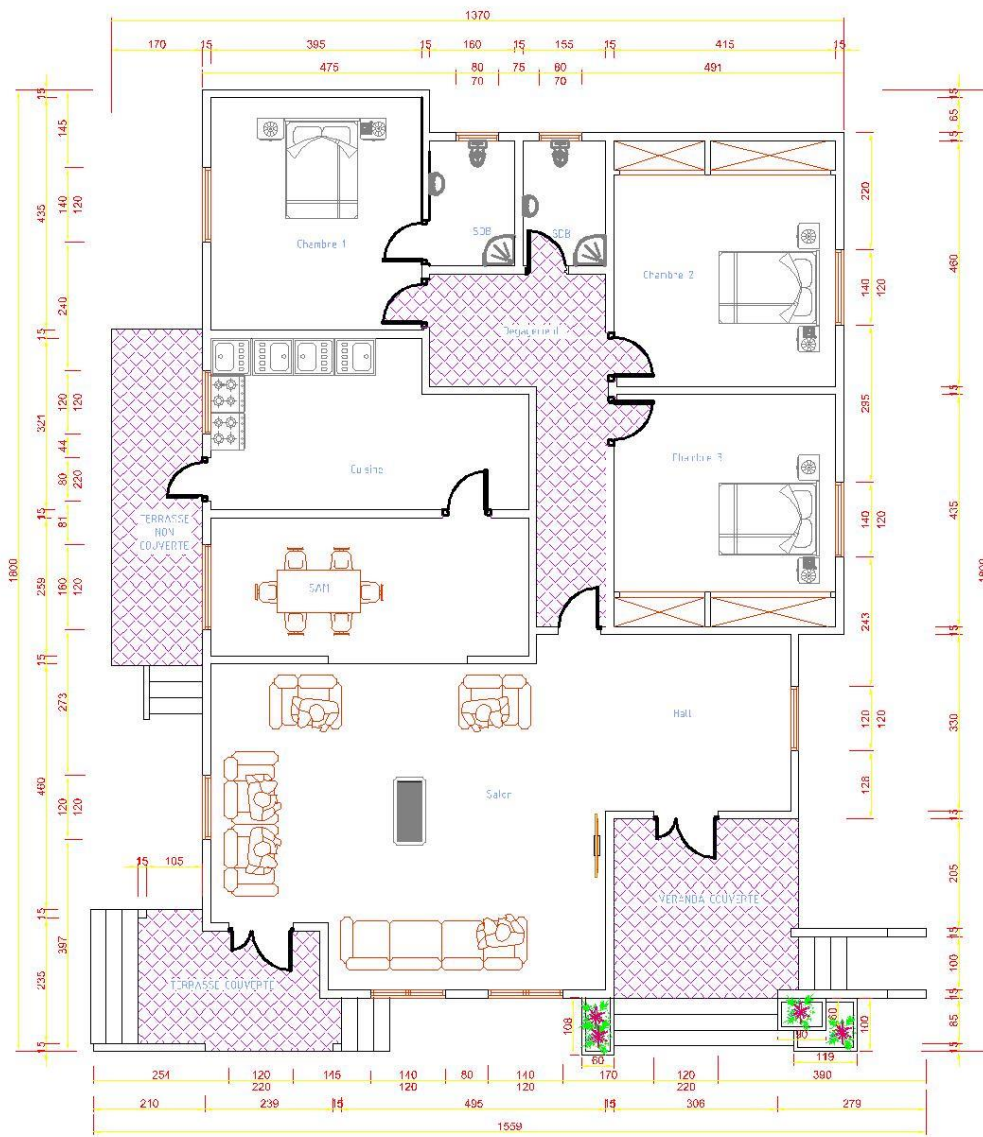

VUE EN PLAN

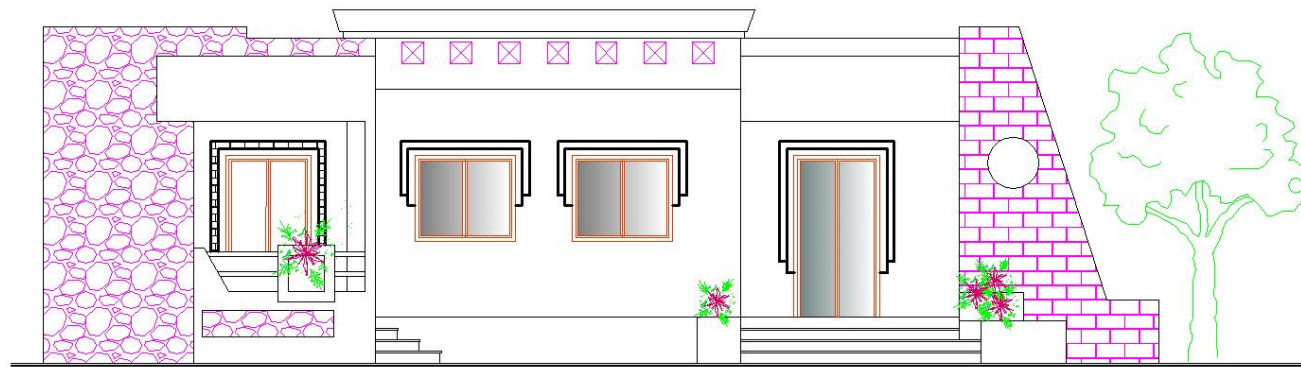

FAÇADE PRINCIPALE

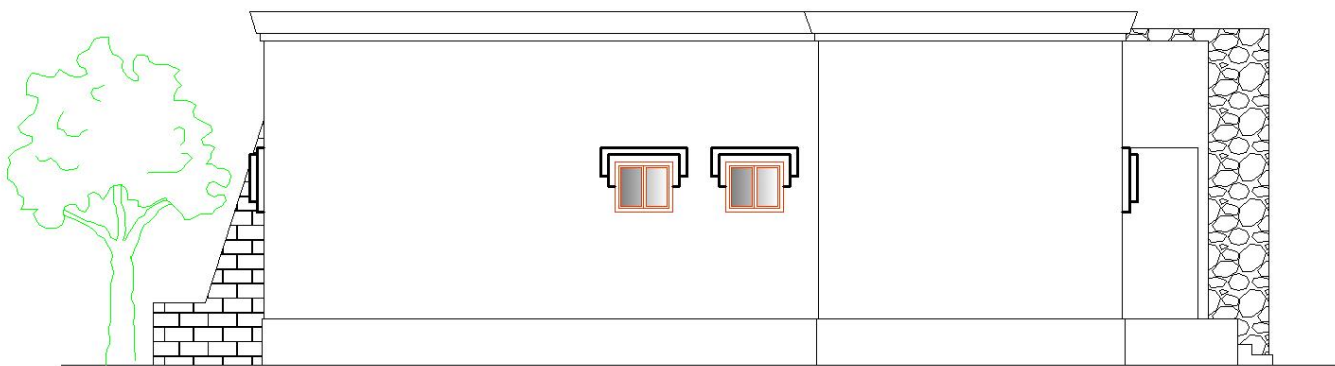

FAÇADE POSTERIEURE

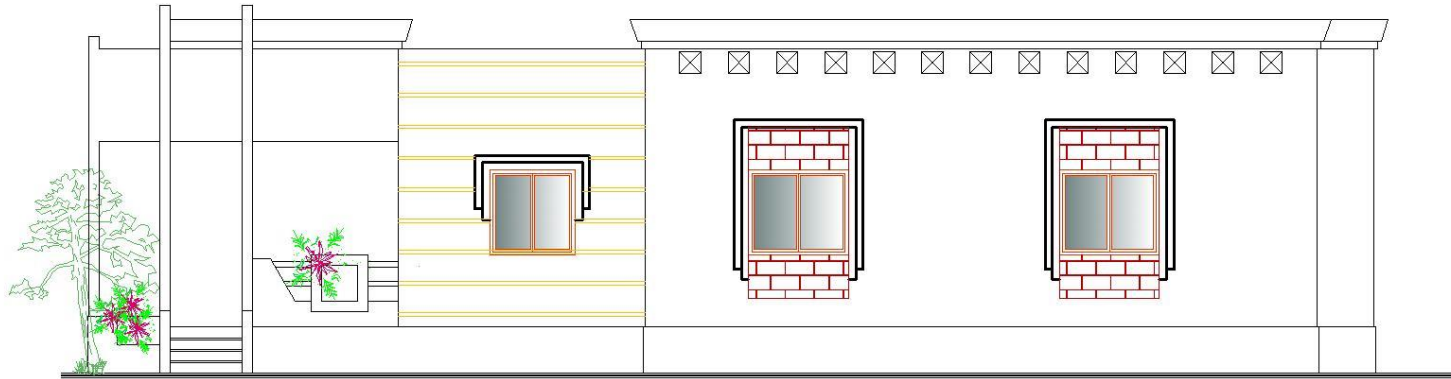

FAÇADE LATÉRALE DROITE

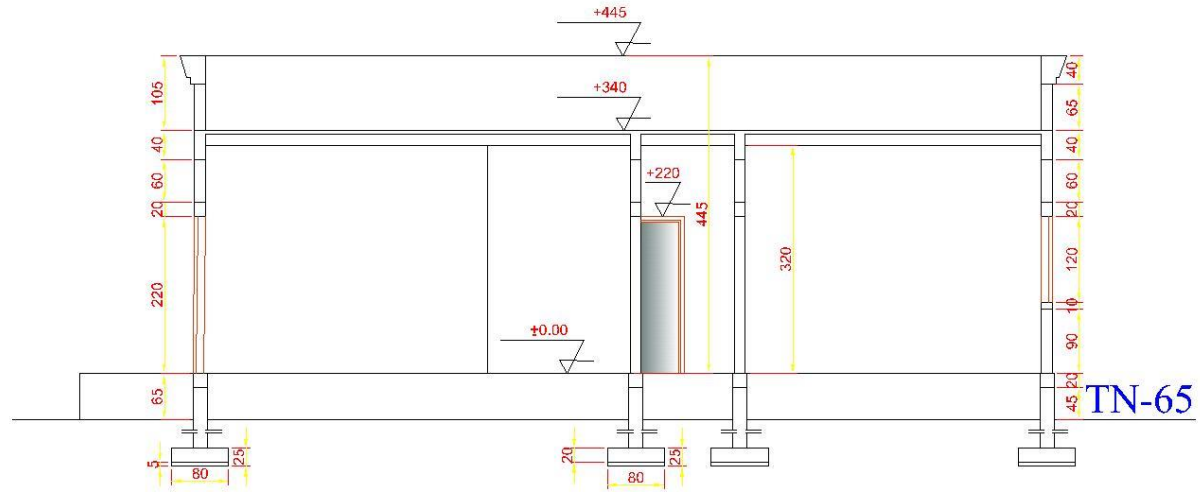

COUPE

BLOC DE TOILETTE

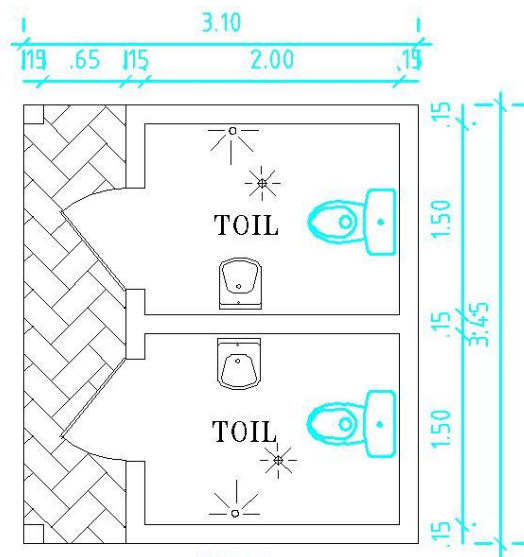

PLAN

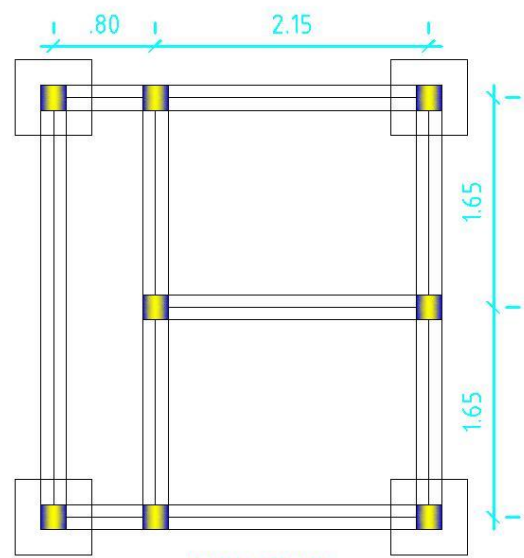

FONDATION

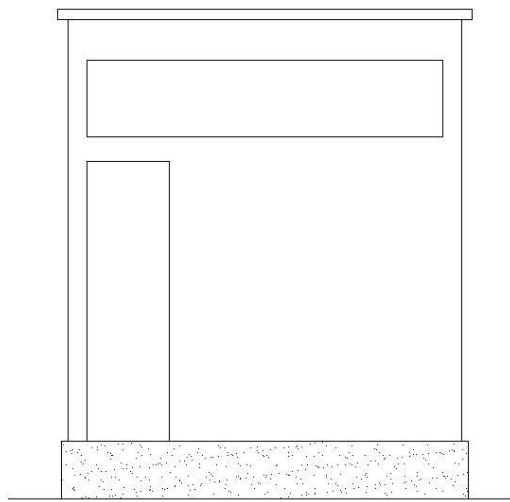

FACADE LATÉRALE

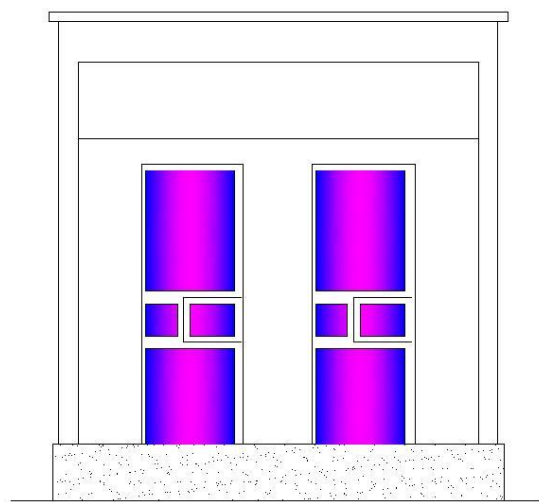

FACADE PRINCIPALE

FOSSE SEPTIQUE

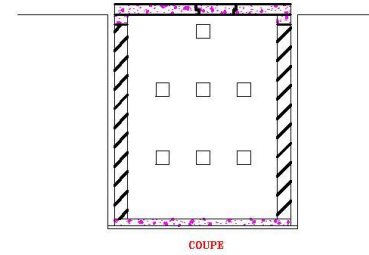
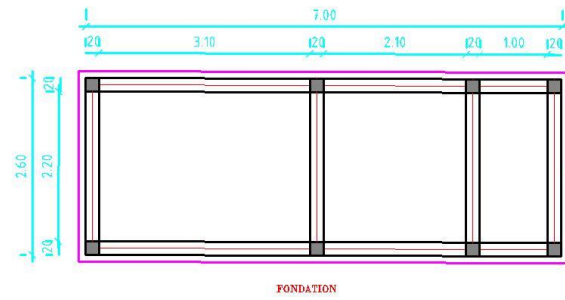
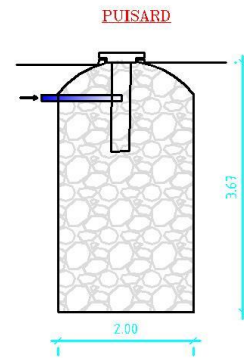
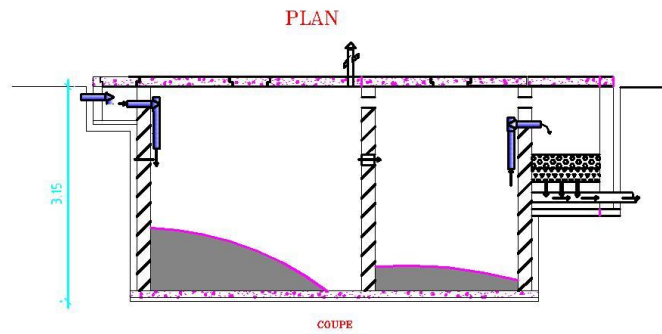
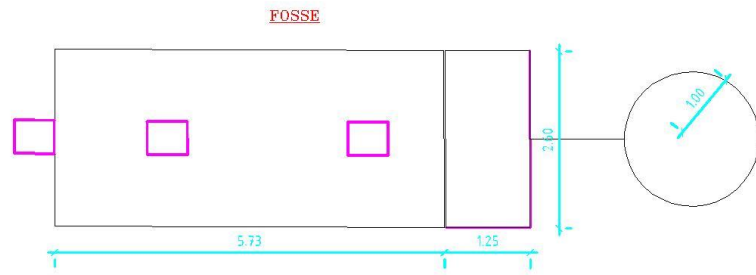

ATELIER

Atelier / 9

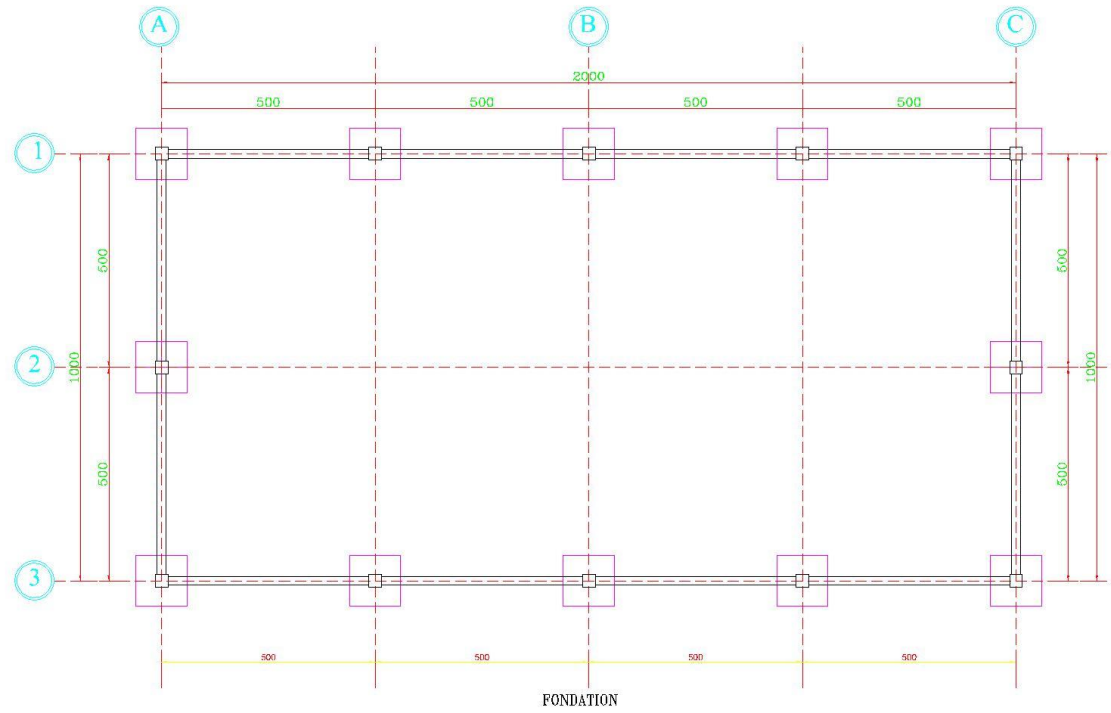

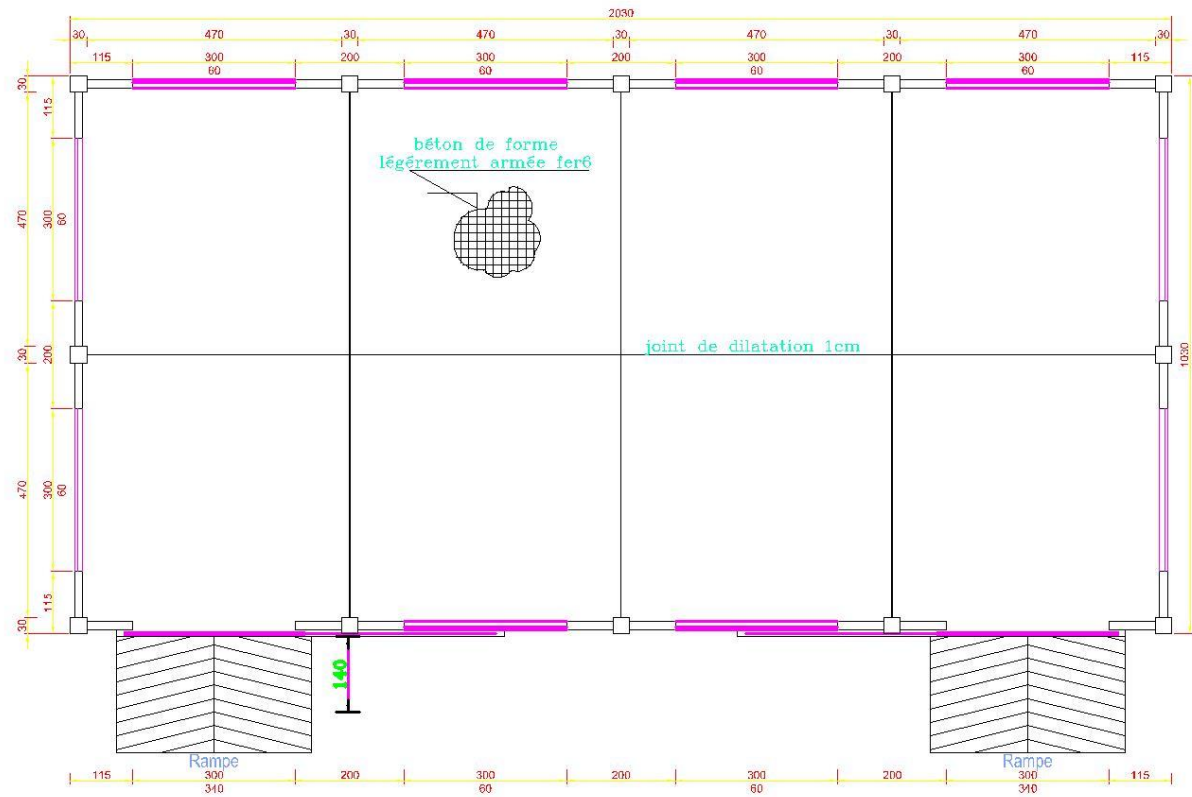

VUE EN PLAN

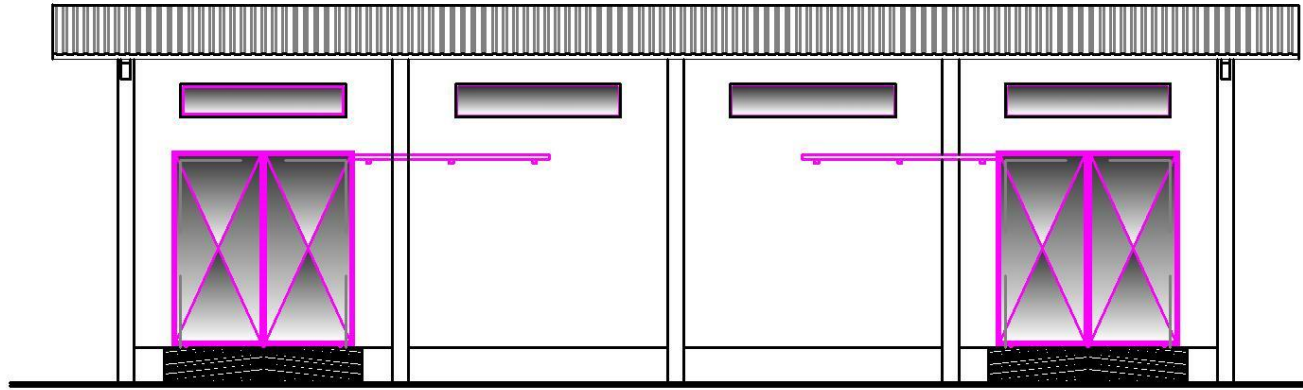

FAÇADE PRINCIPALE

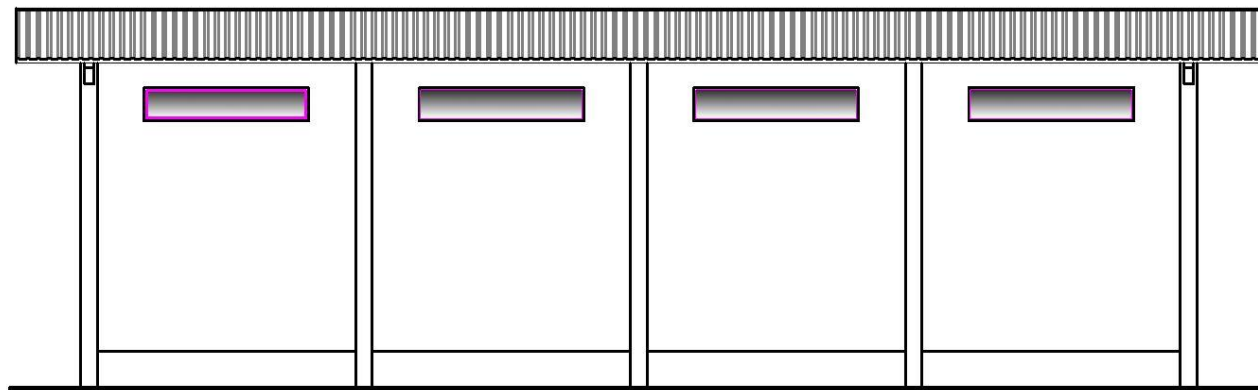

FAÇADE POSTÉRIEURE

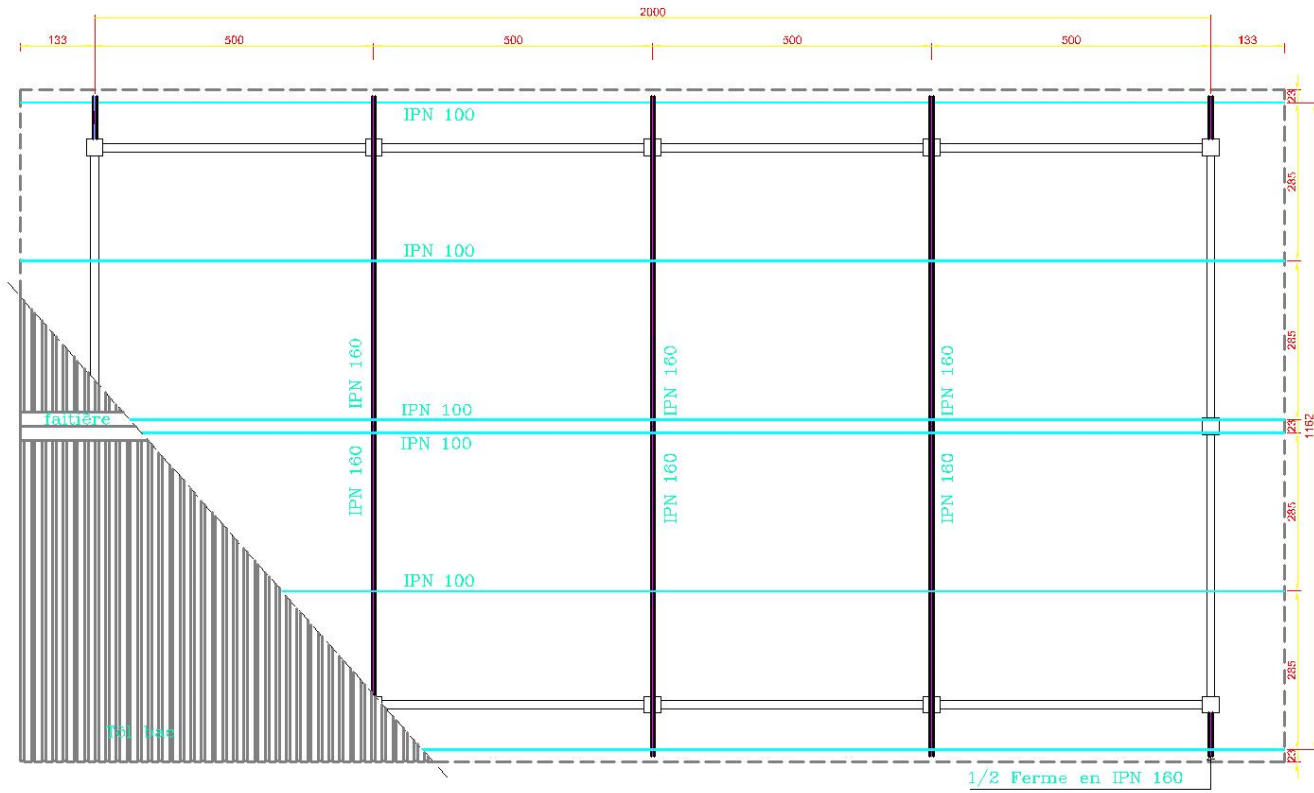

VUE EN PLAN DE LA TOITURE

ETABLE

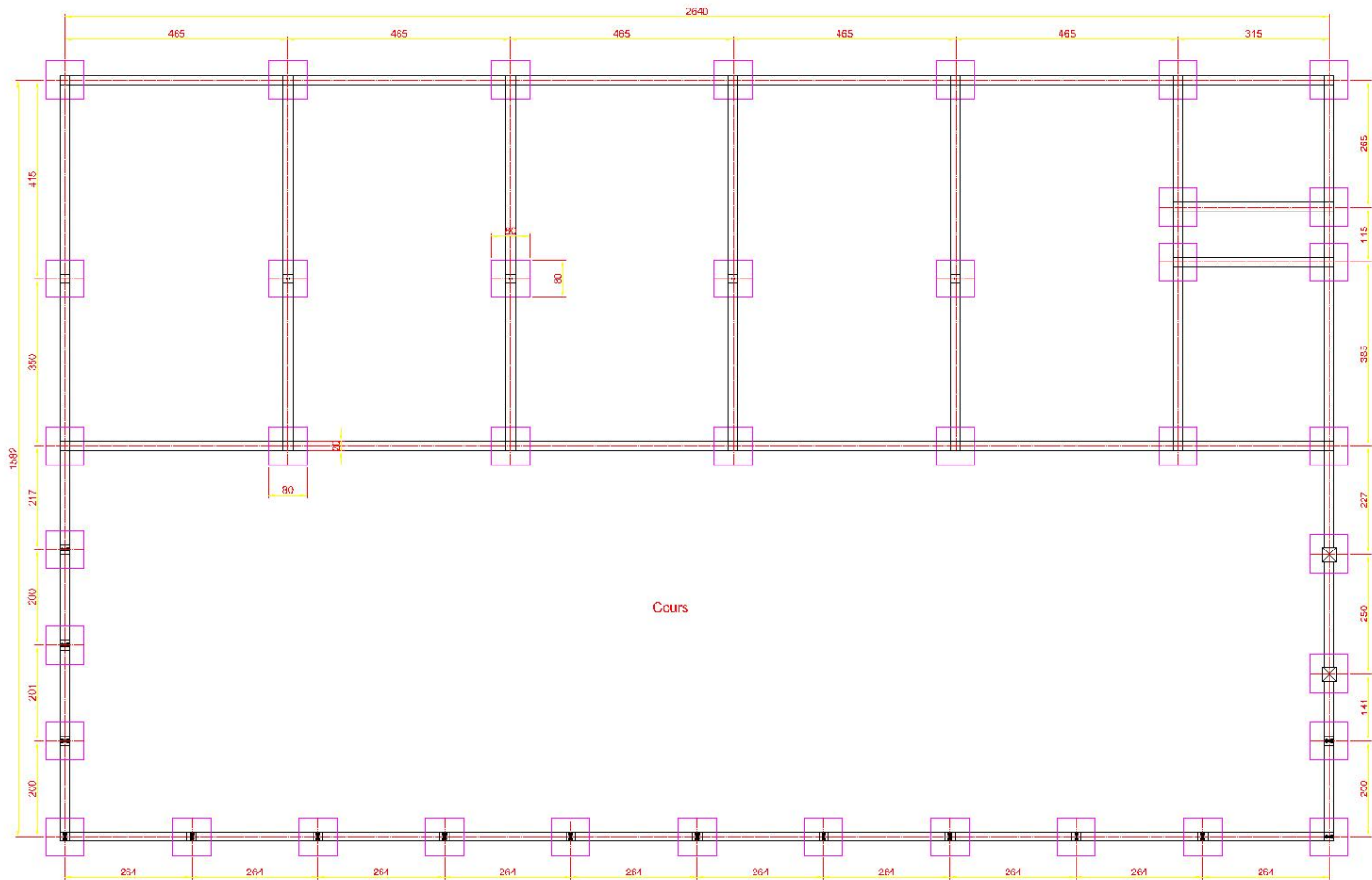

VUE EN PLAN

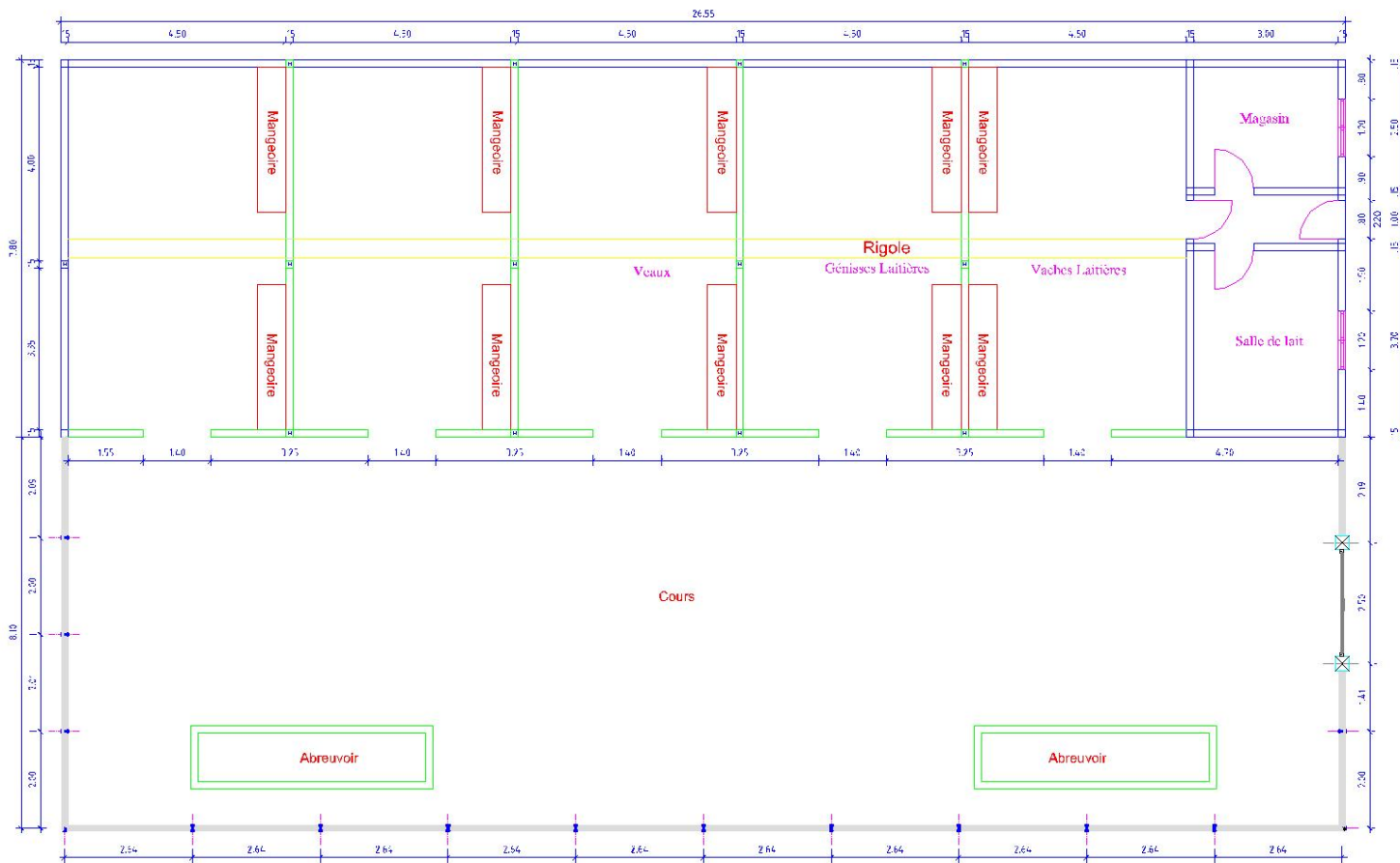

VUE EN PLAN

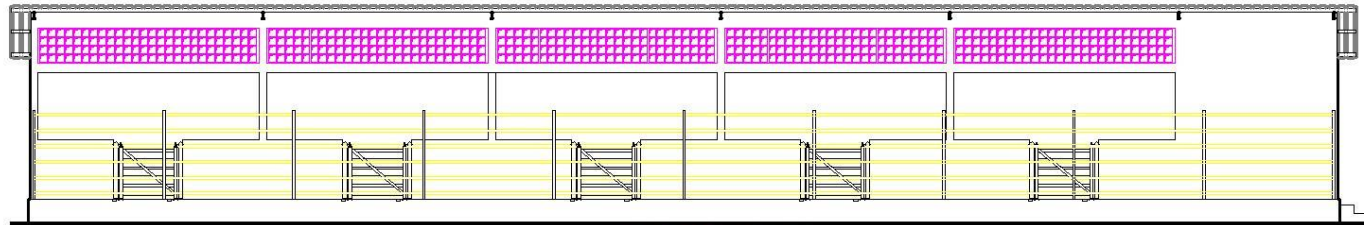

FAÇADE PRINCIPALE 1

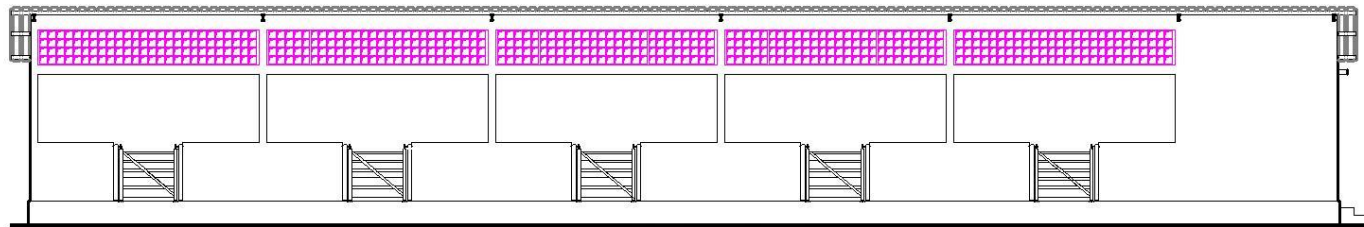

FAÇADE PRINCIPALE 2



FAÇADE POSTÉRIEURE

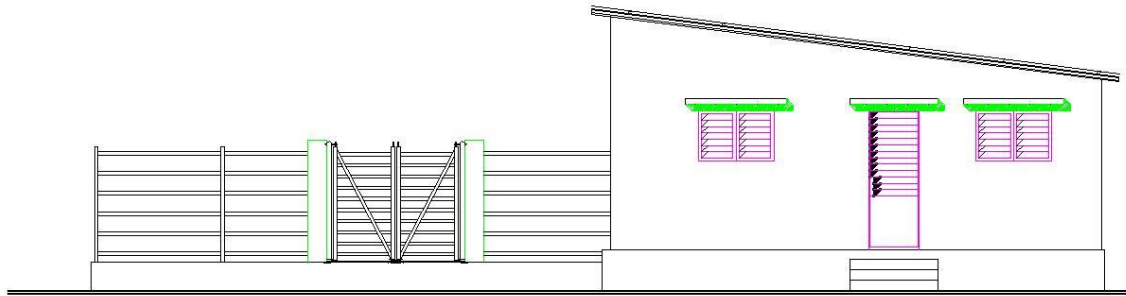

FAÇADE DROITE

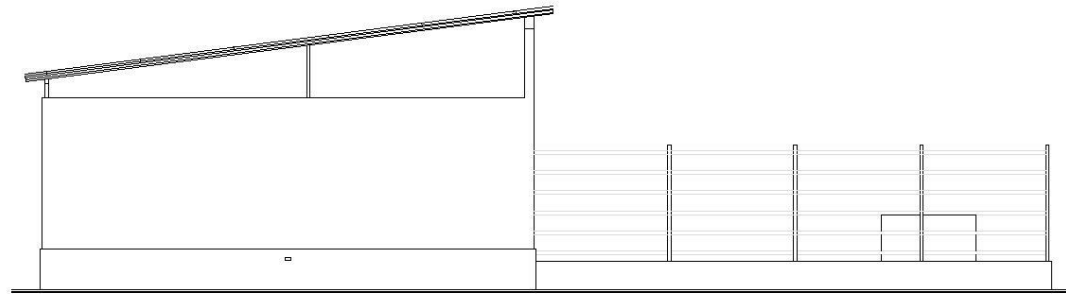

FAÇADE GAUCHE

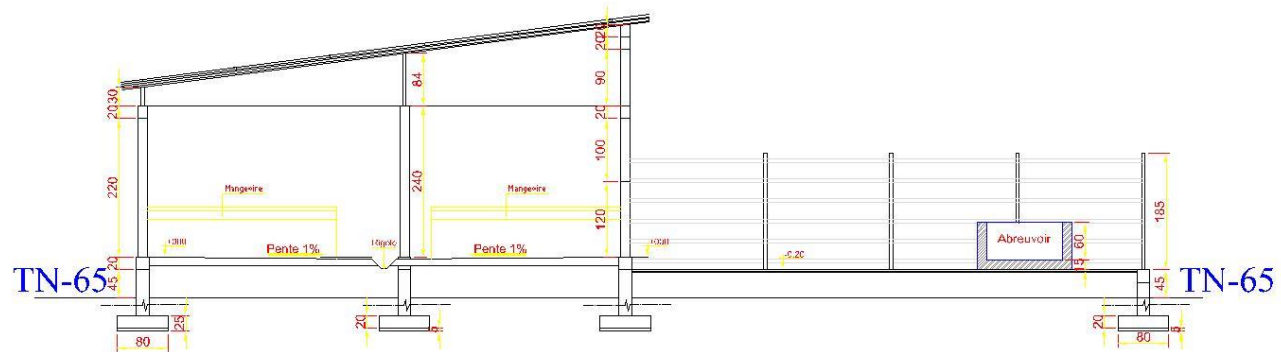

COUPE A-A

PARC D'EMBOUCHE

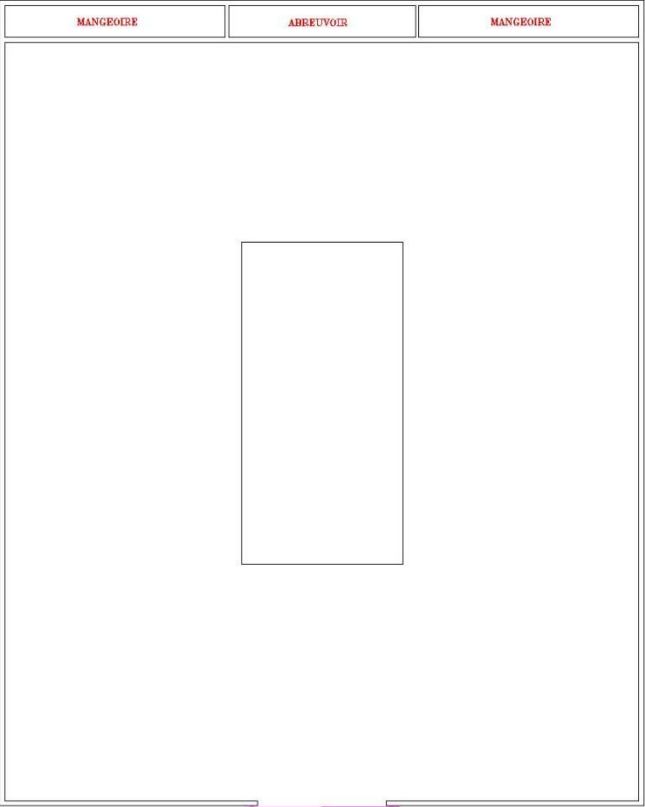

PLAN PARC

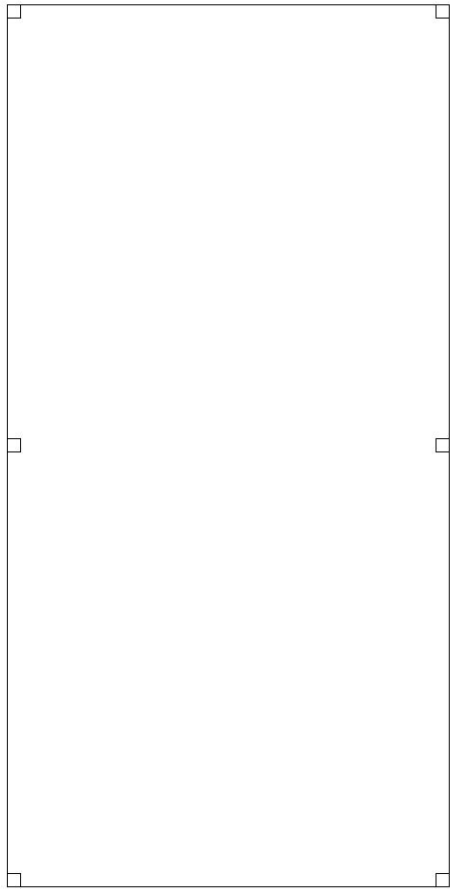

PLAN HANGAR

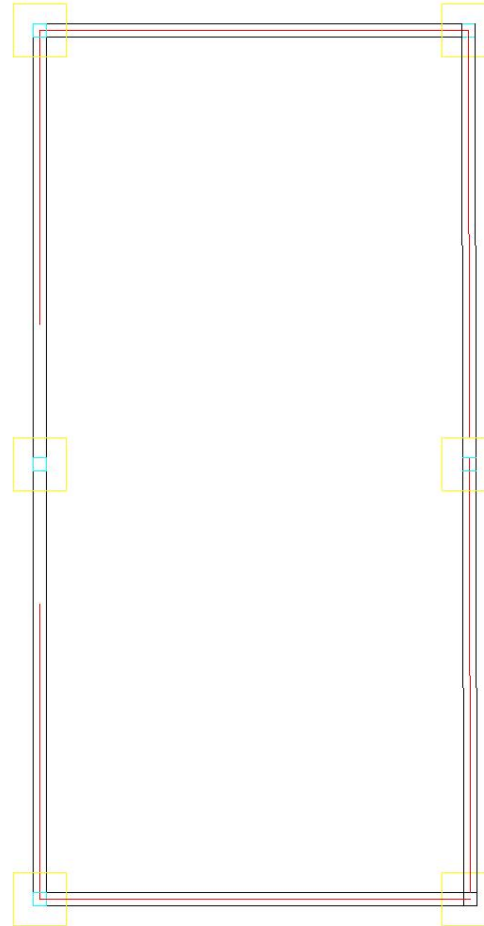

FONDATION

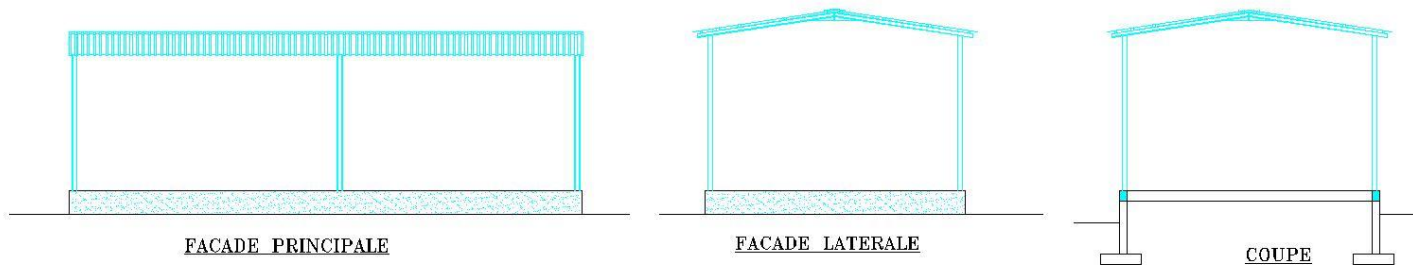
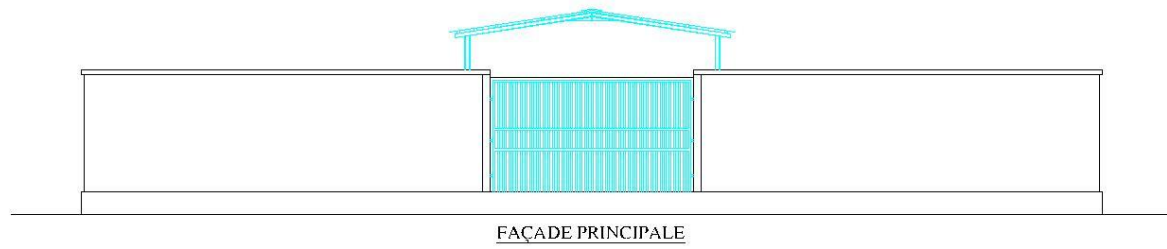

PARC DE TRANSIT

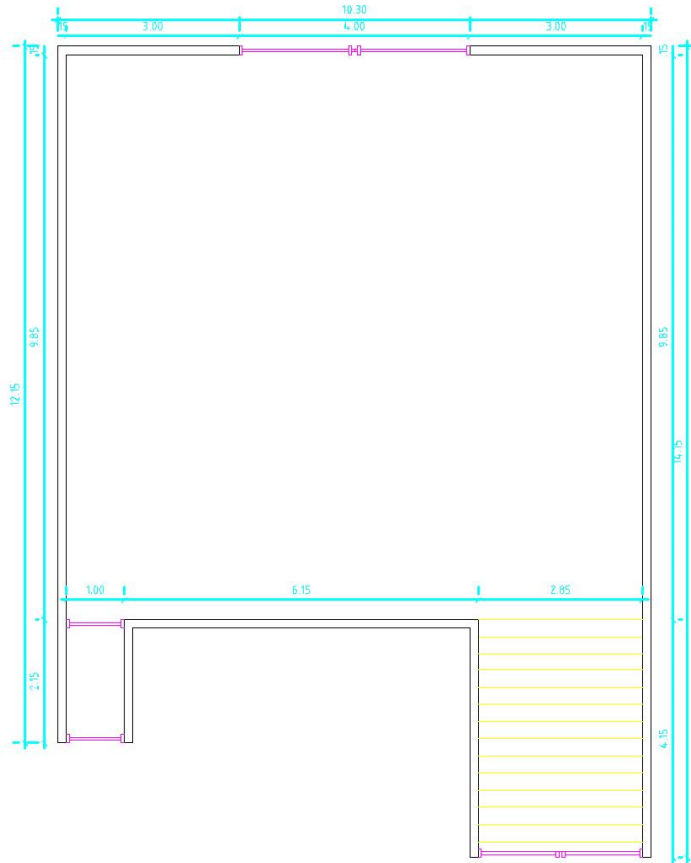

PLAN

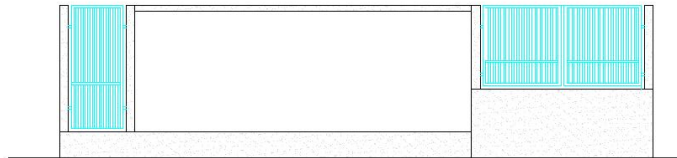

FACADE PRINCIPALE

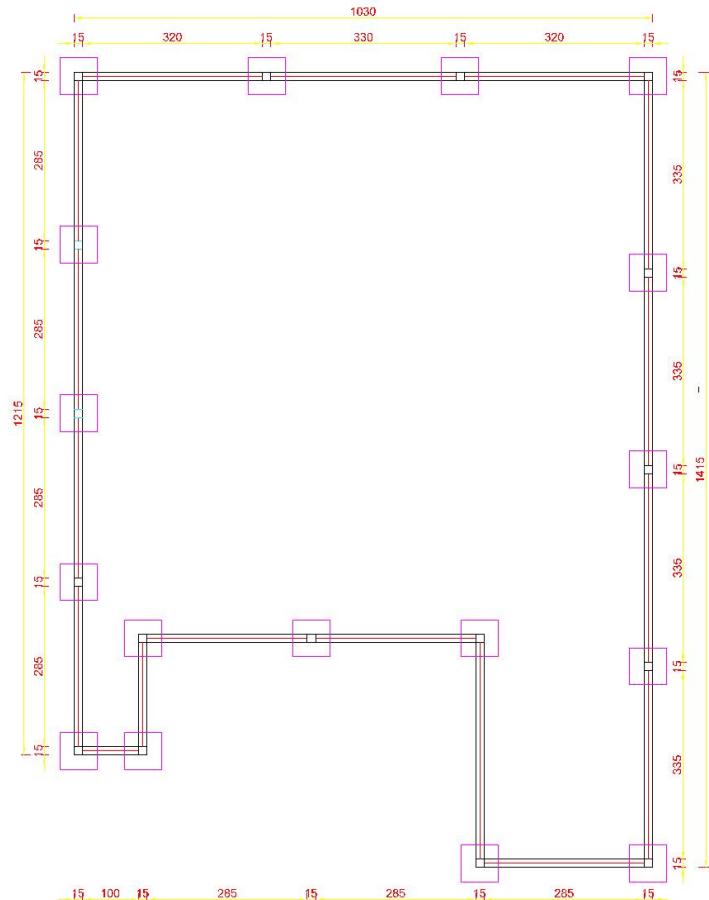

FONDATION

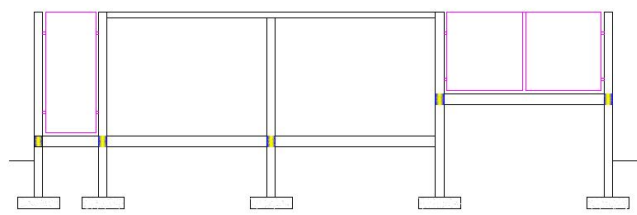

COUPE

LOGEMENT DU GARDIEN

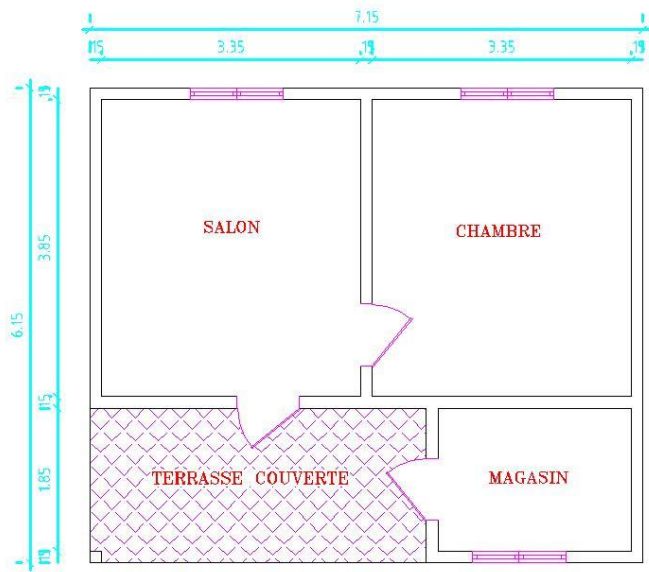

PLAN

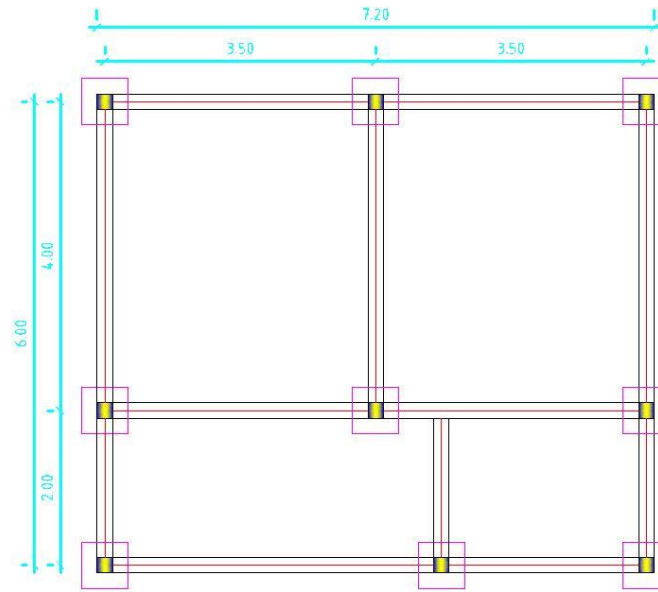

FONDATION

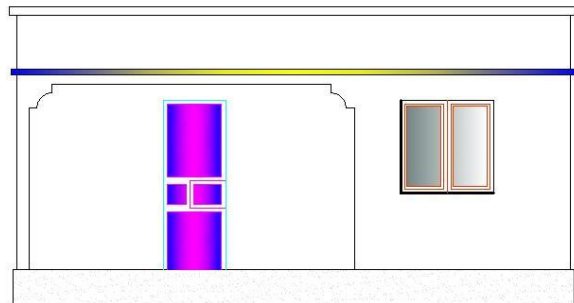

FACADE PRINCIPALE

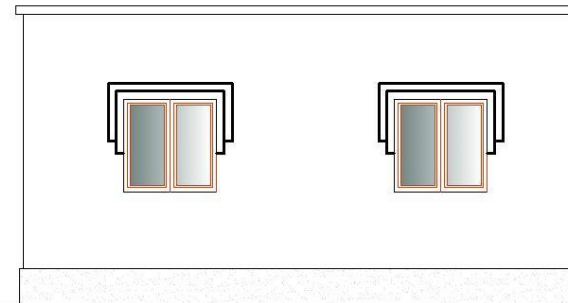

FACADE POSTERIEURE

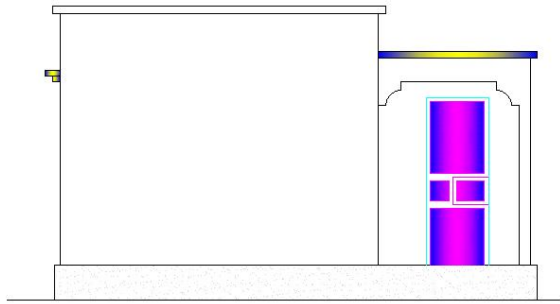

FACADE LATÉRALE DROITE

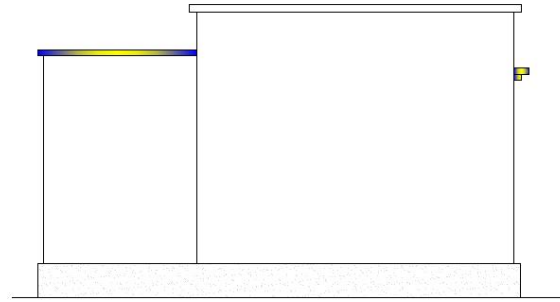

FACADE LATÉRALE DROITE

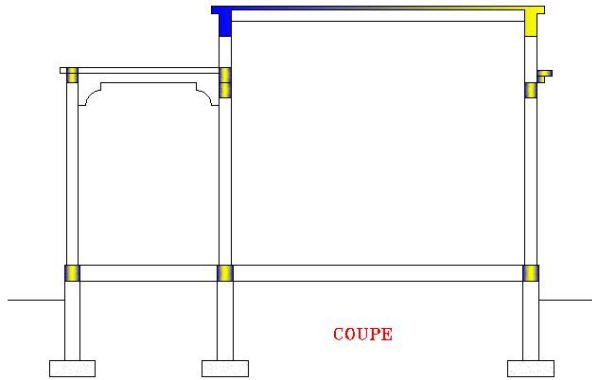

COUPE

POULAILLER POUR PONDEUSE

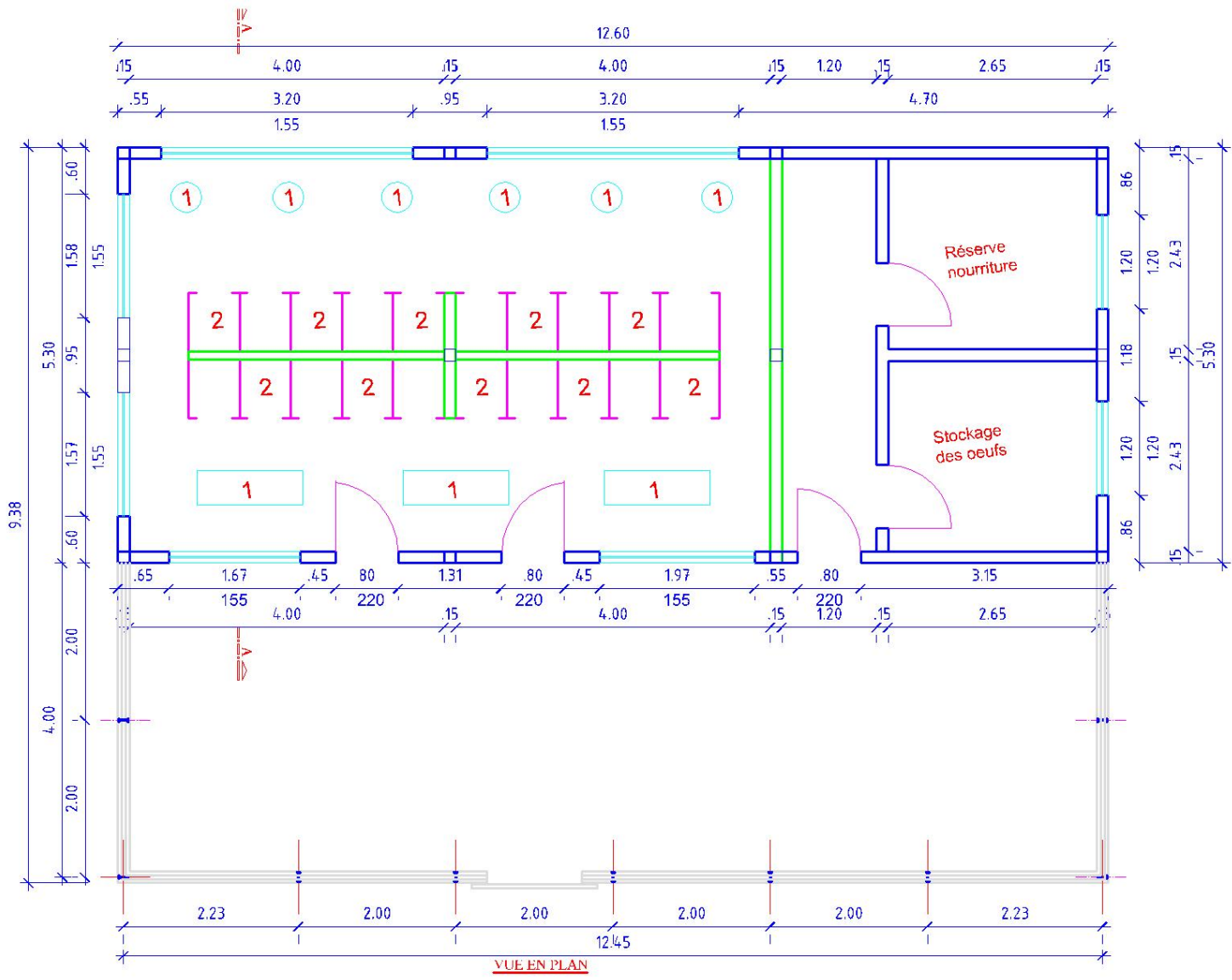

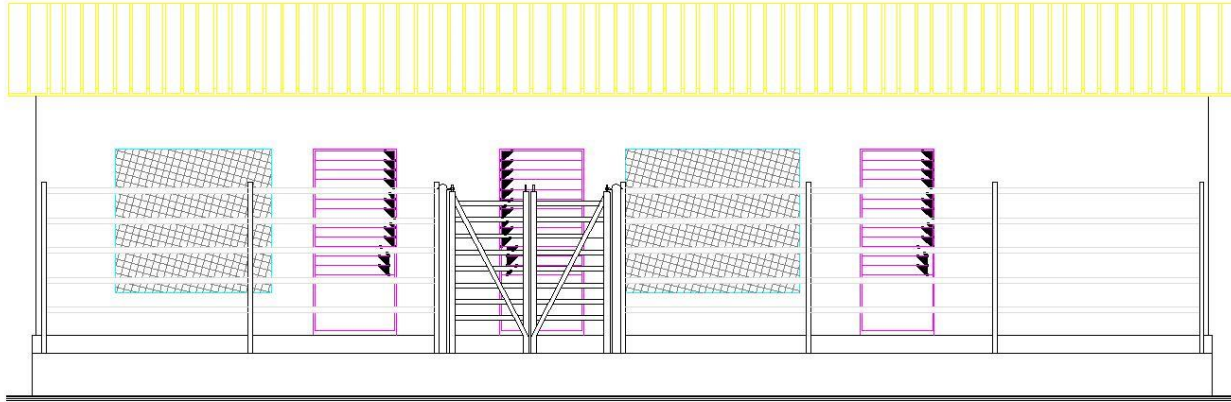

FAÇADE PRINCIPALE

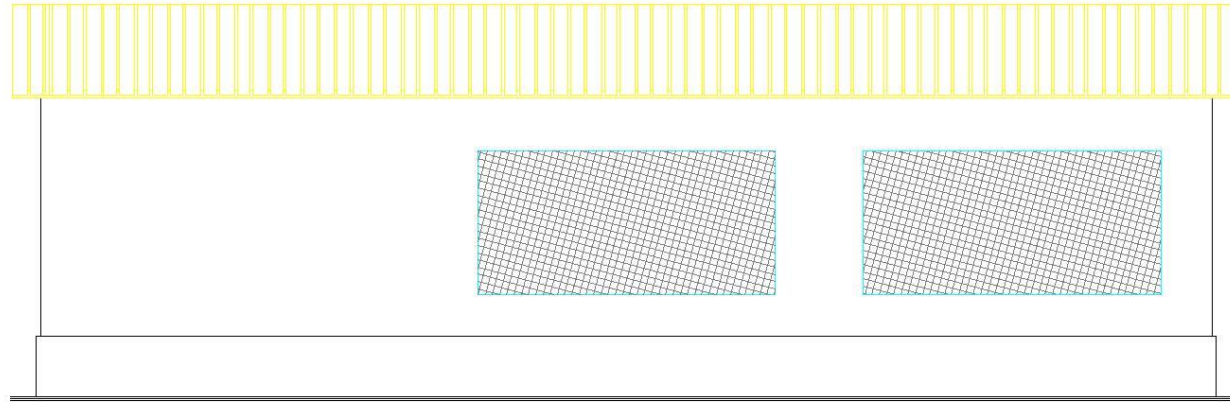

FAÇADE POSTÉRIEURE

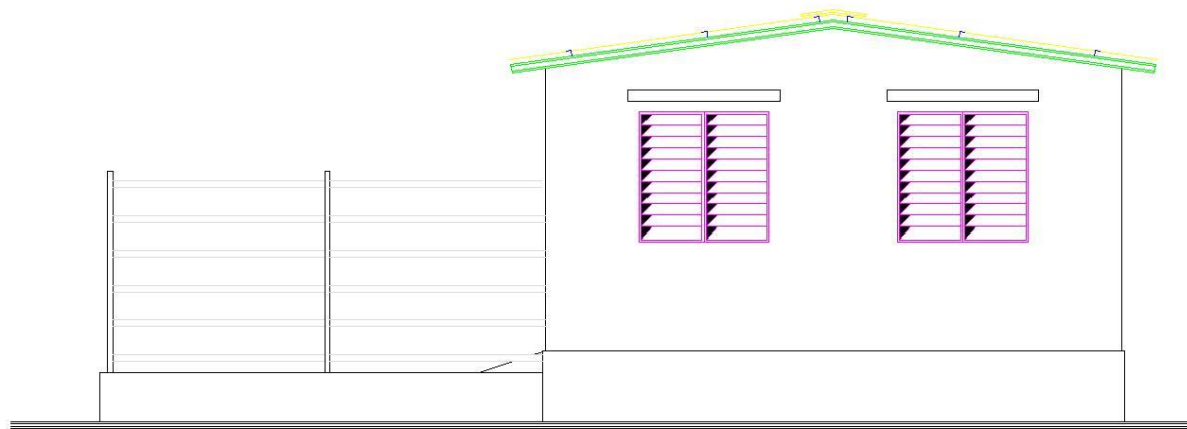

FAÇADE.LAT.DROITE

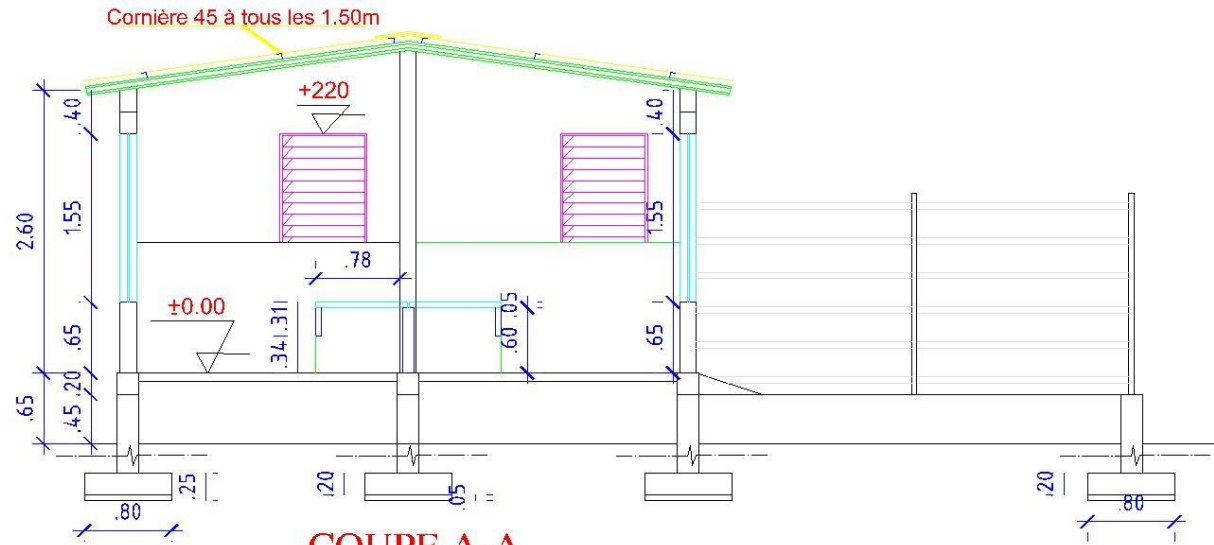

COUPE A-A

POULAILLER POULET DE CHAIR

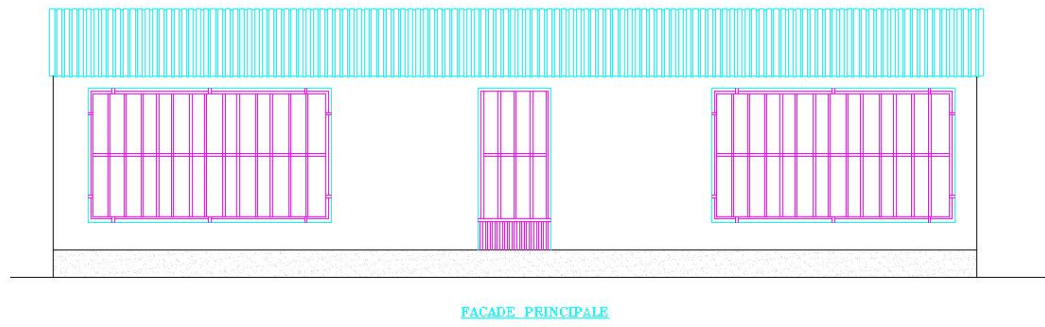
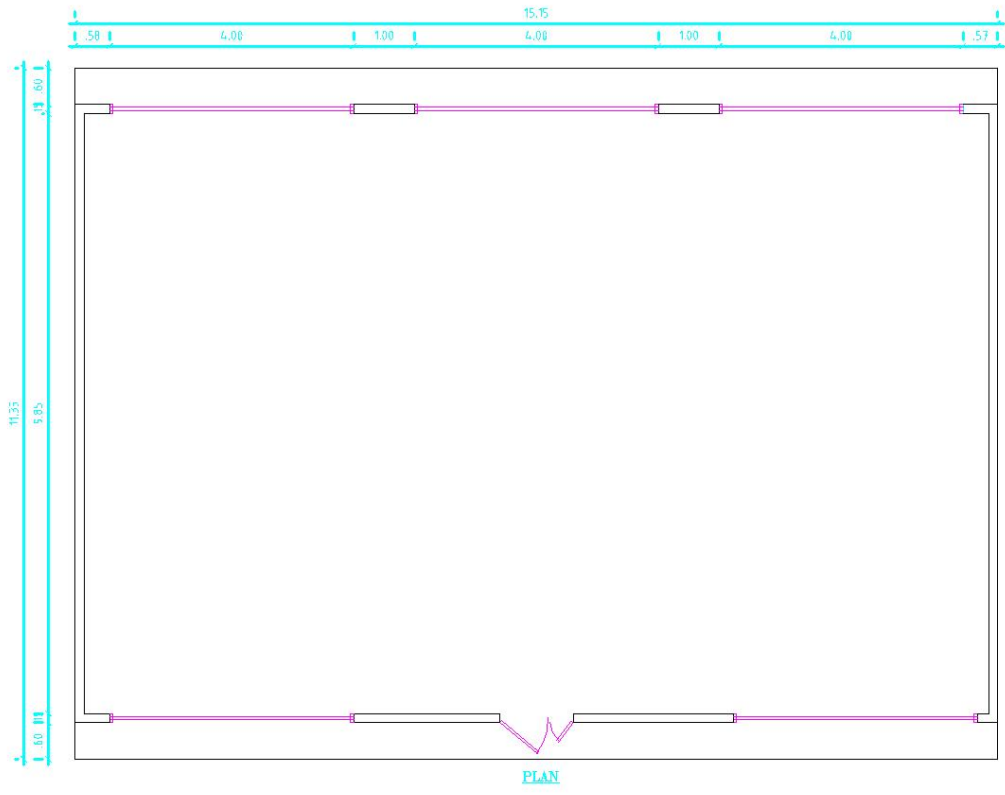

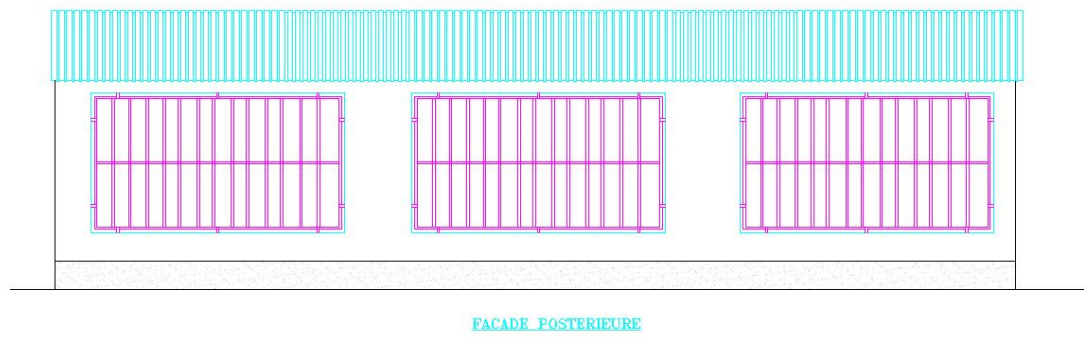
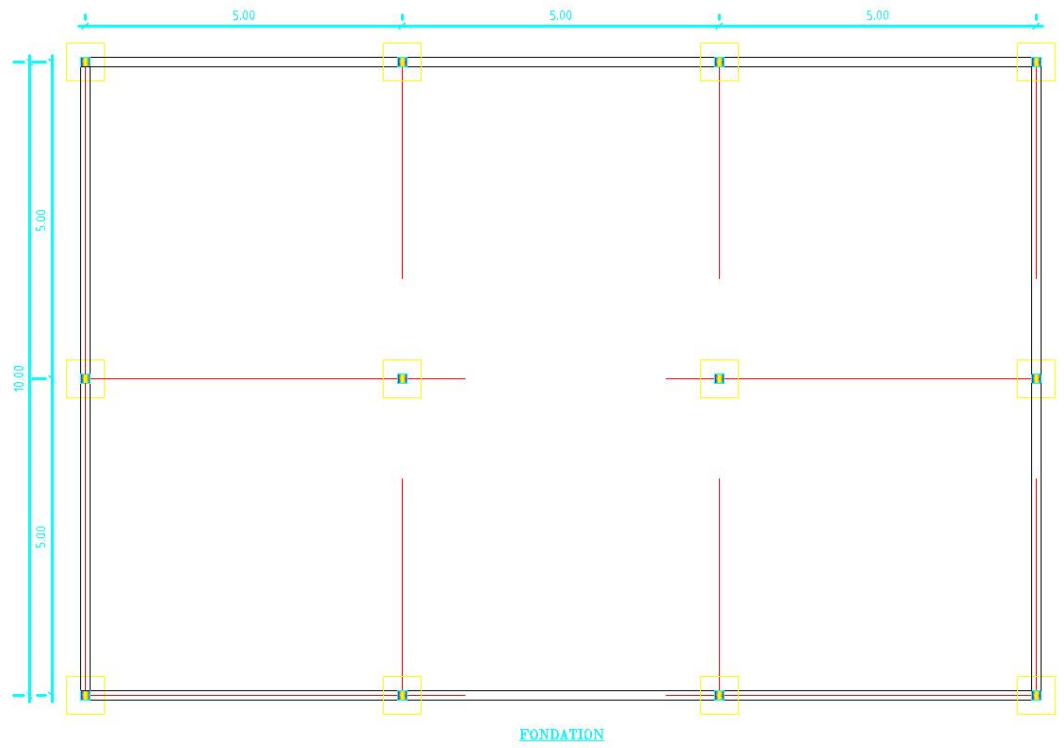

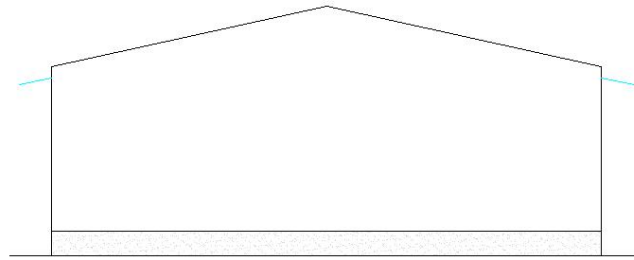

FACADE LATÉRALE

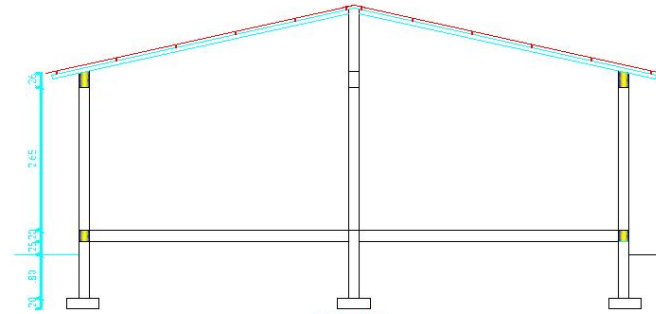

COUPE

CABINET VETERINAIRE

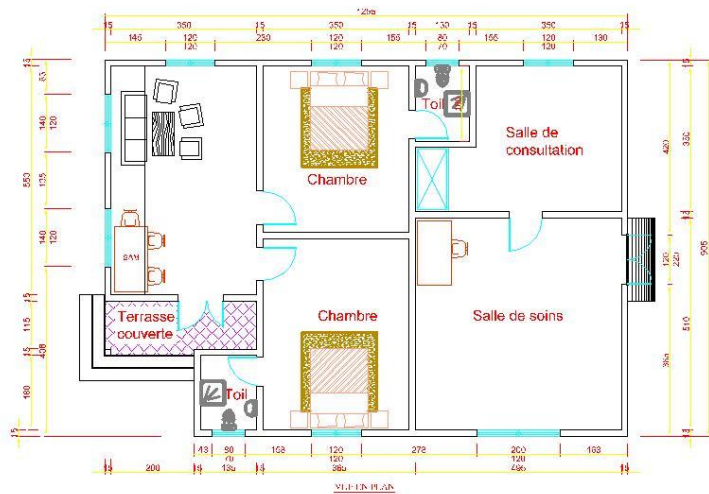

VUE EN PLAN

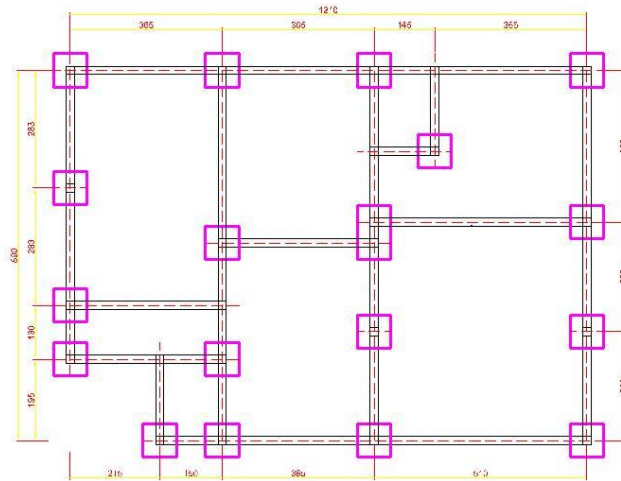

FONDATION

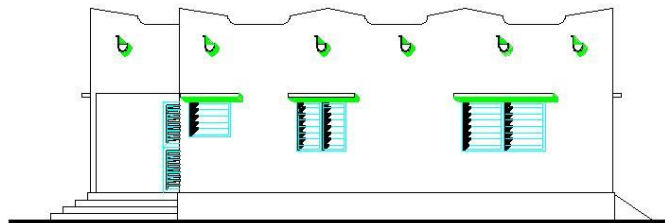

FACADE PRINCIPALE

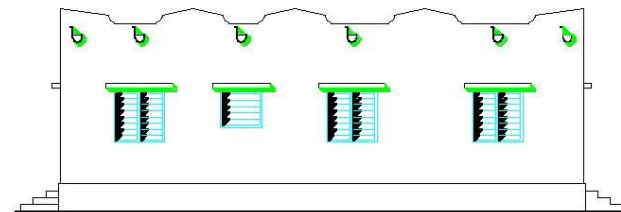

FACADE POSTERIEURE

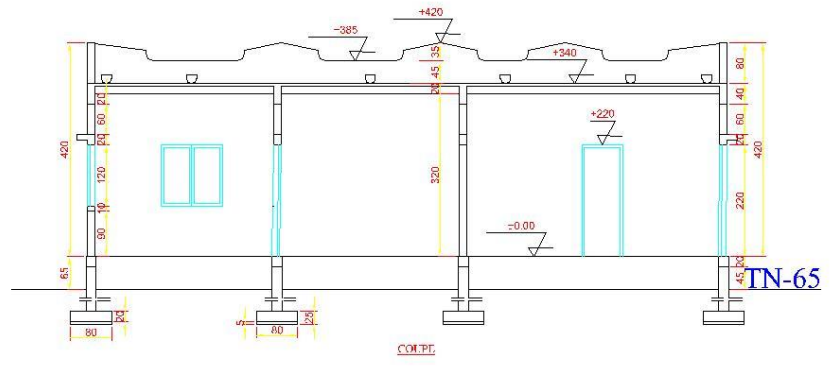
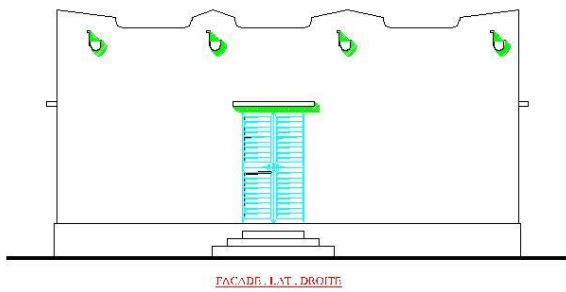

BLOC DE CUISINE EXTERIEURE

Cuisine exterieure / J17

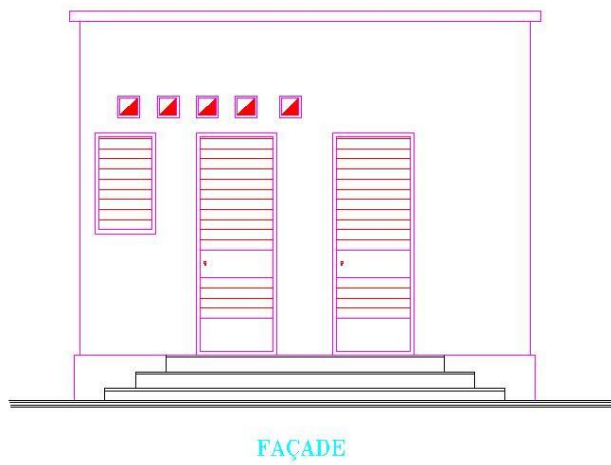
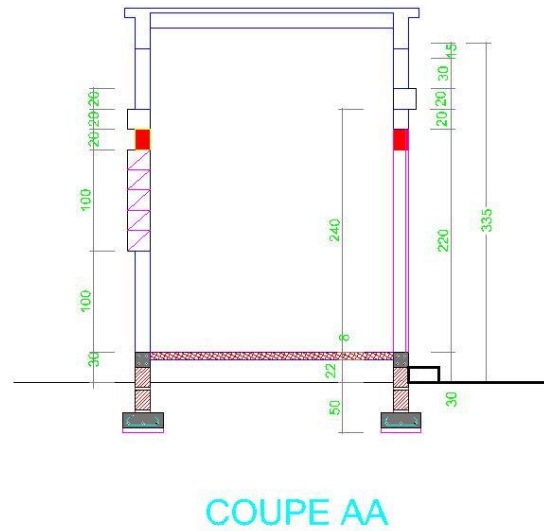
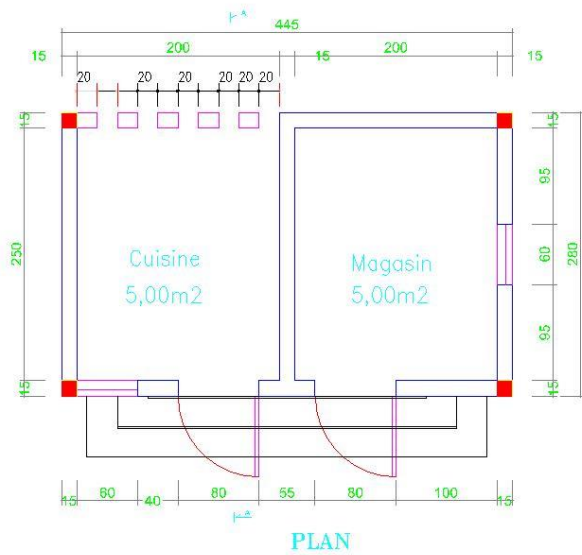

ECLOSERIE

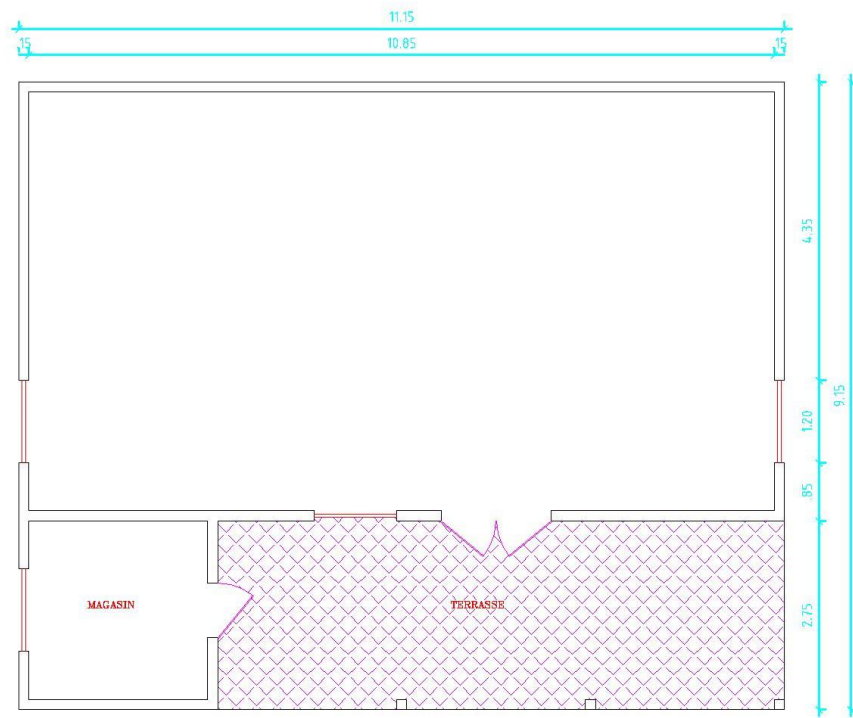

PLAN

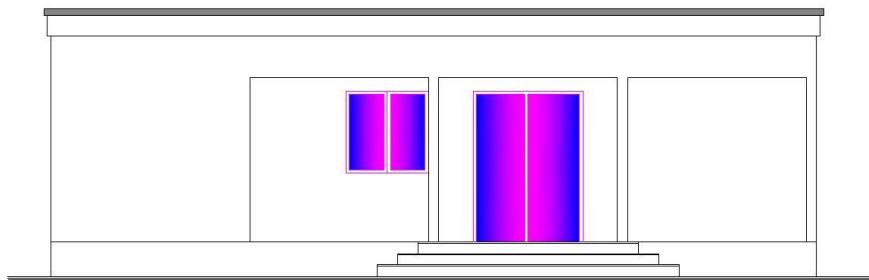

FACADE PRINCIPALE

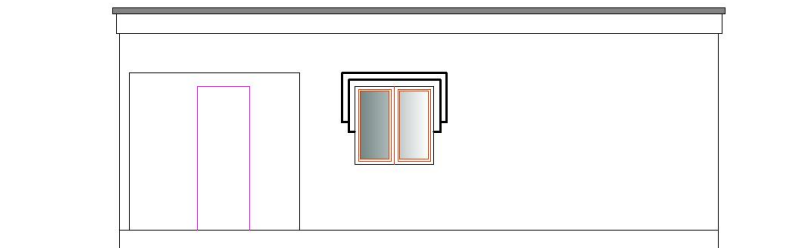
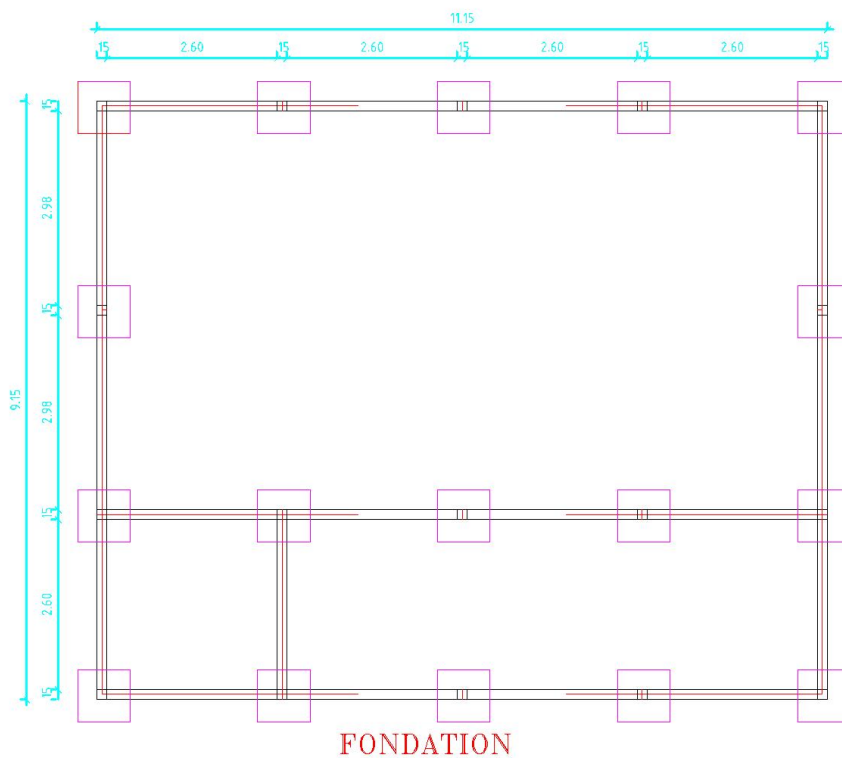

FACADE LATERALE DROITE

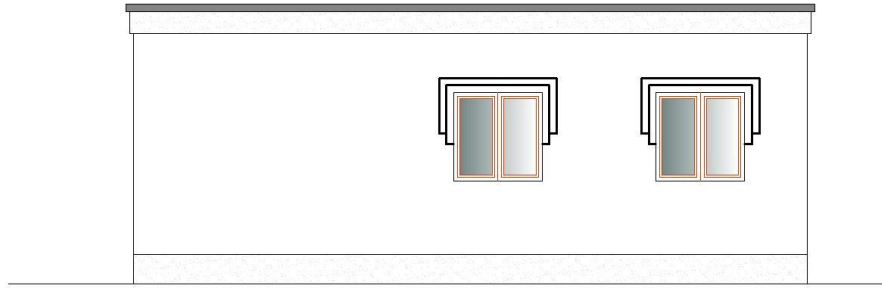

FACADE LATÉRALE GAUCHE

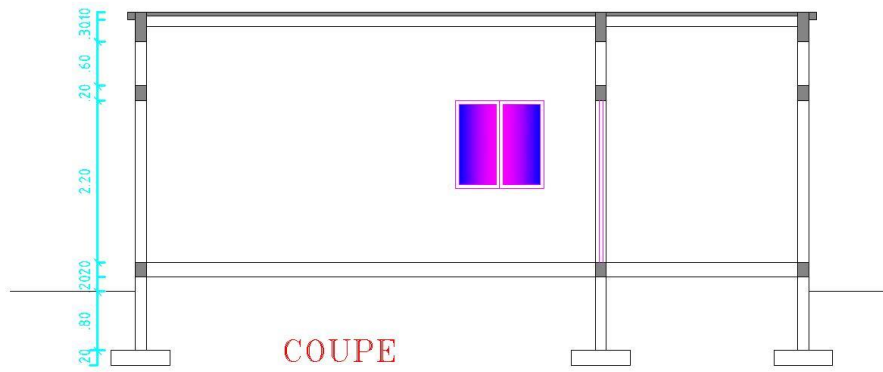

COUPE

CHATEAU D'EAU

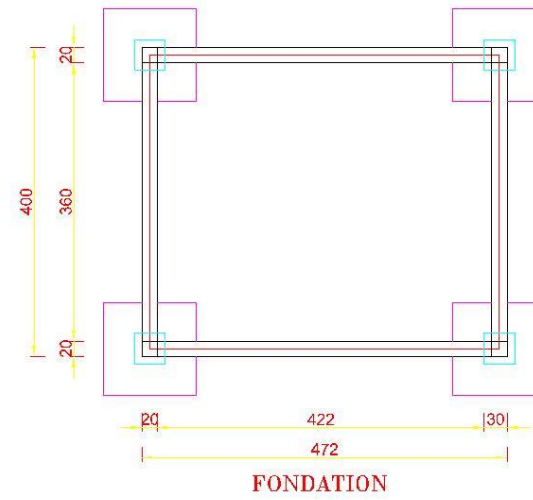
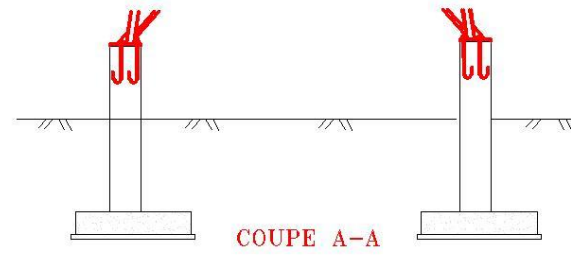
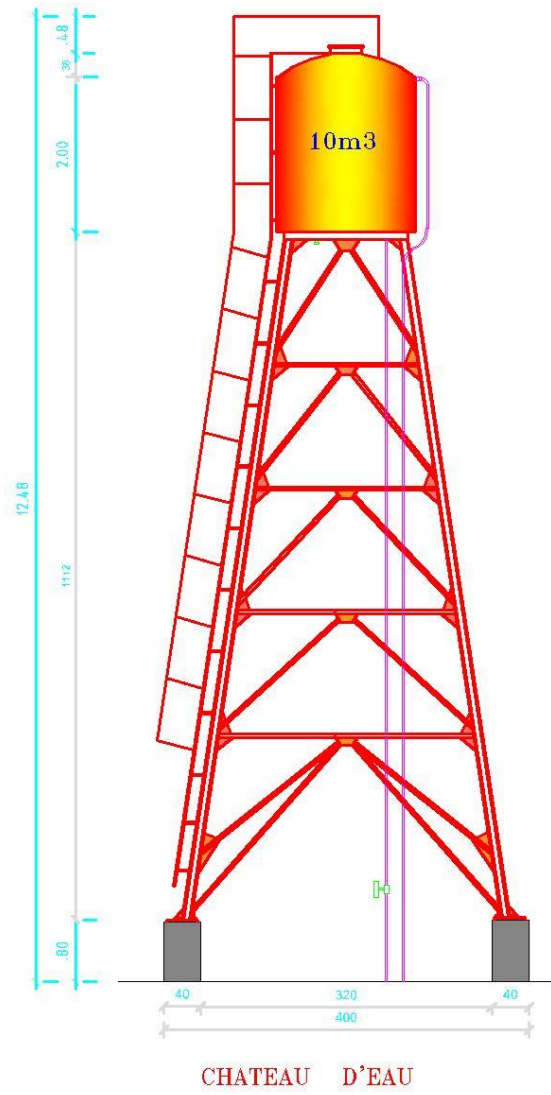

VIVIER

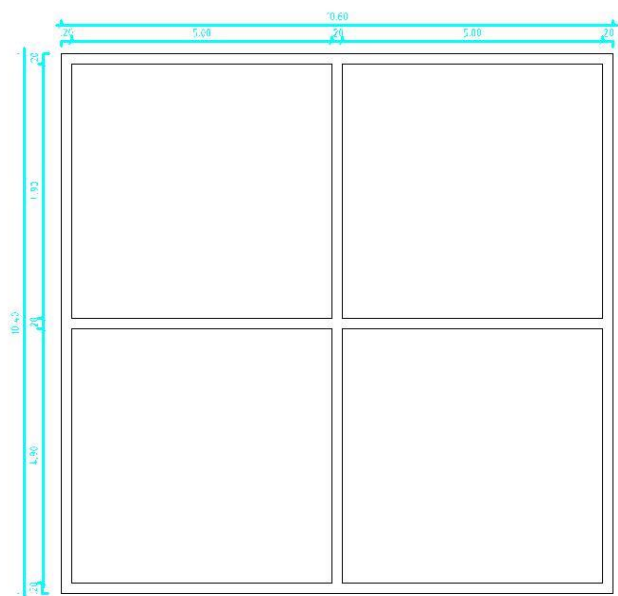

PLAN

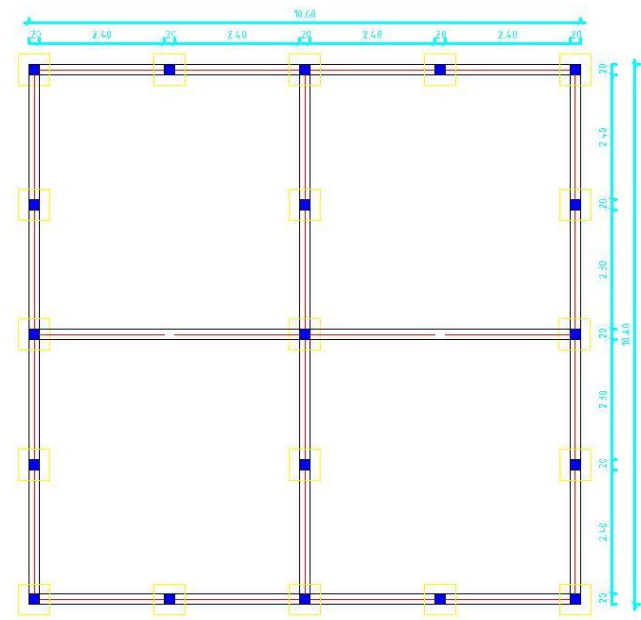

PONDATION

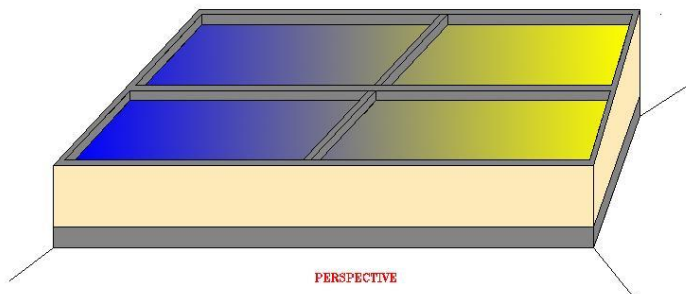

PERSPECTIVE

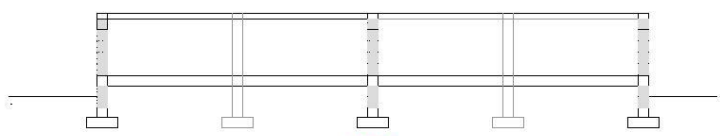

COUPE

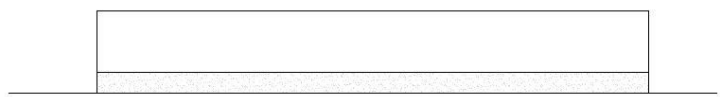

FACADE PRINCIPALE

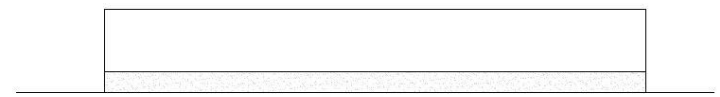

FACADE LATÉRALE

BASSIN PISCICOLE

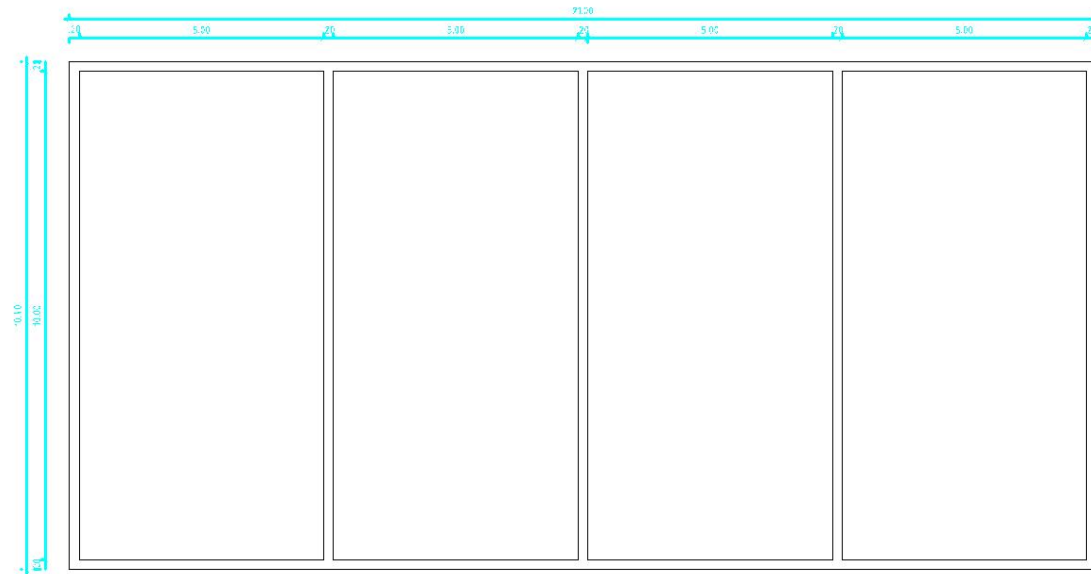

PLAN

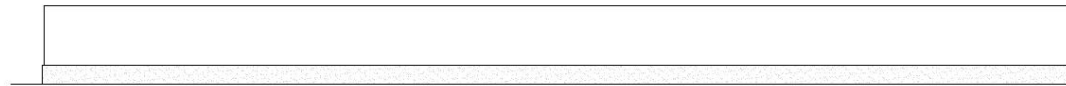

FACADE PRINCIPALE

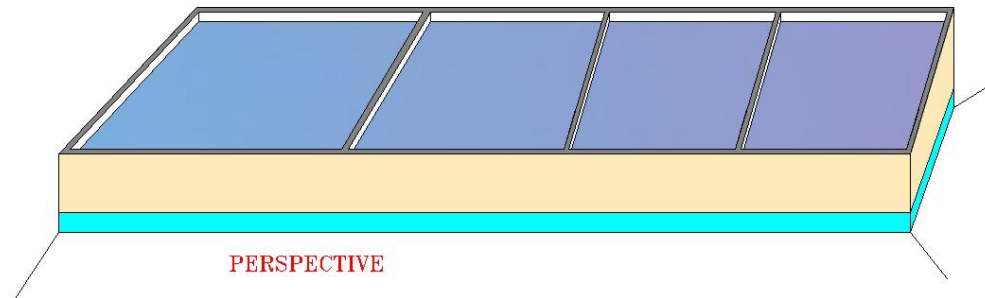

PERSPECTIVE

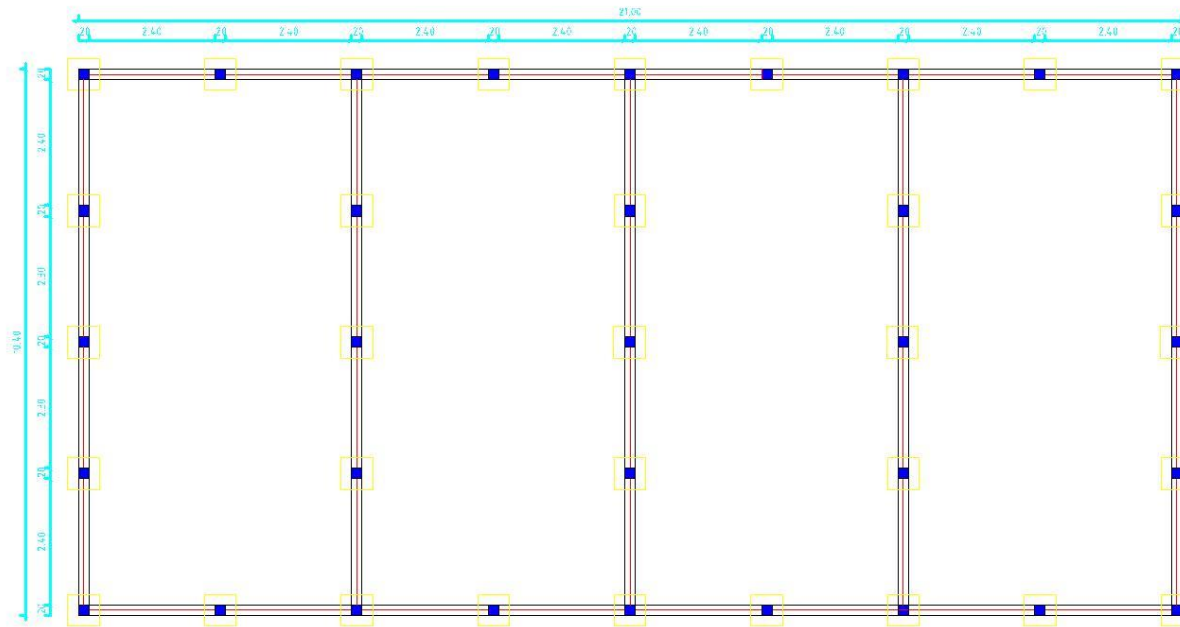

FONDATION

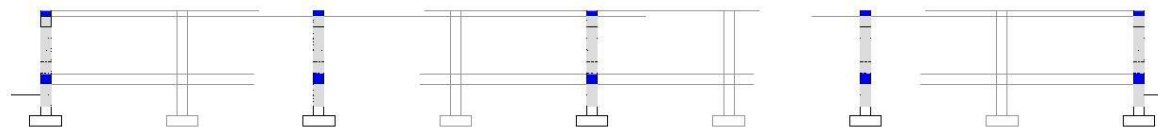

COUPE

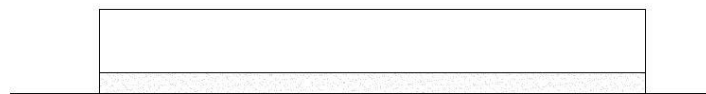

FACADE LATÉRALE

CLOTURE

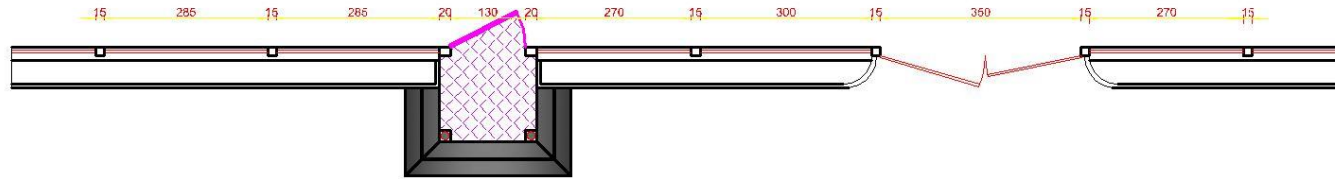

PLAN

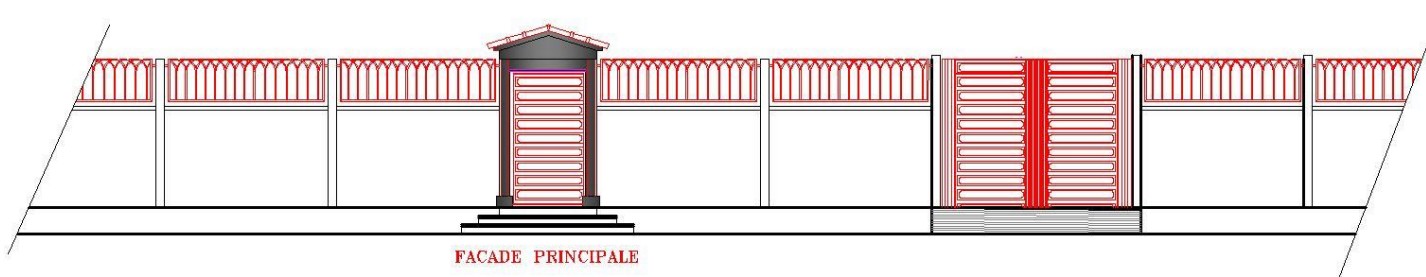

Magasin stockage des produits maraichers à Andiagana

MAGASIN DE STOCKAGE

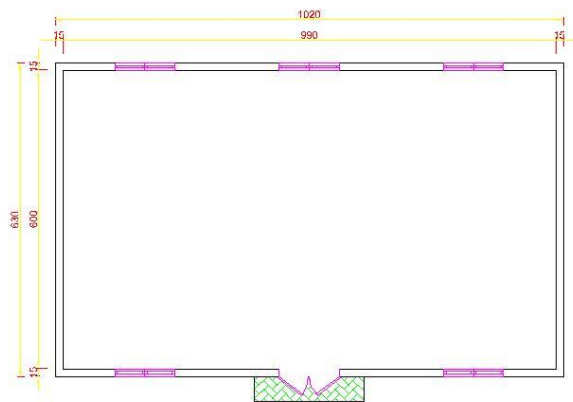

PLAN

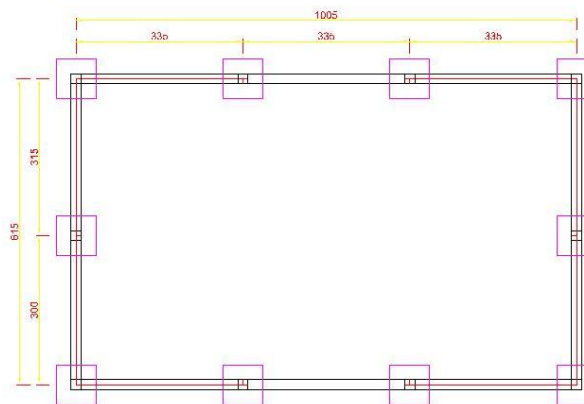

FONDATION

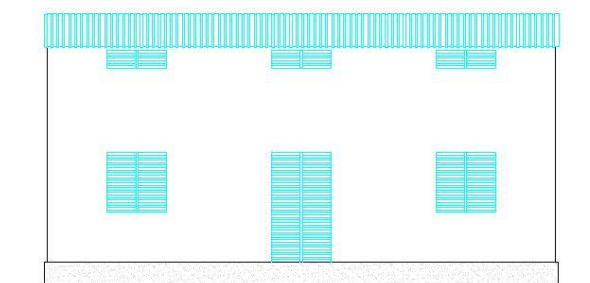

FACADE PRINCIPALE

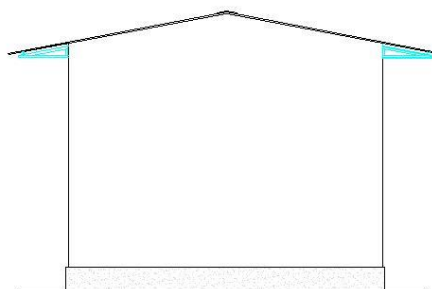

FACADE LATERALE

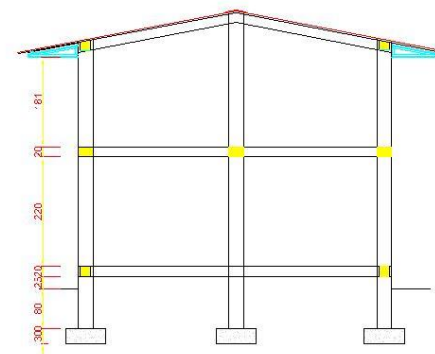

COUPE

CHATEAU D'EAU

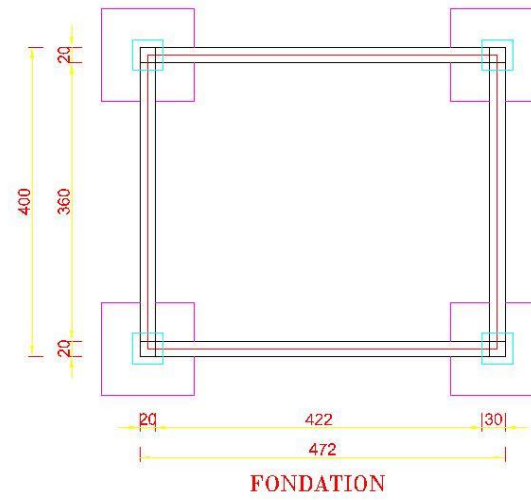
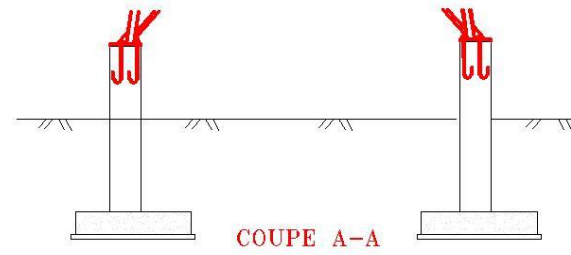
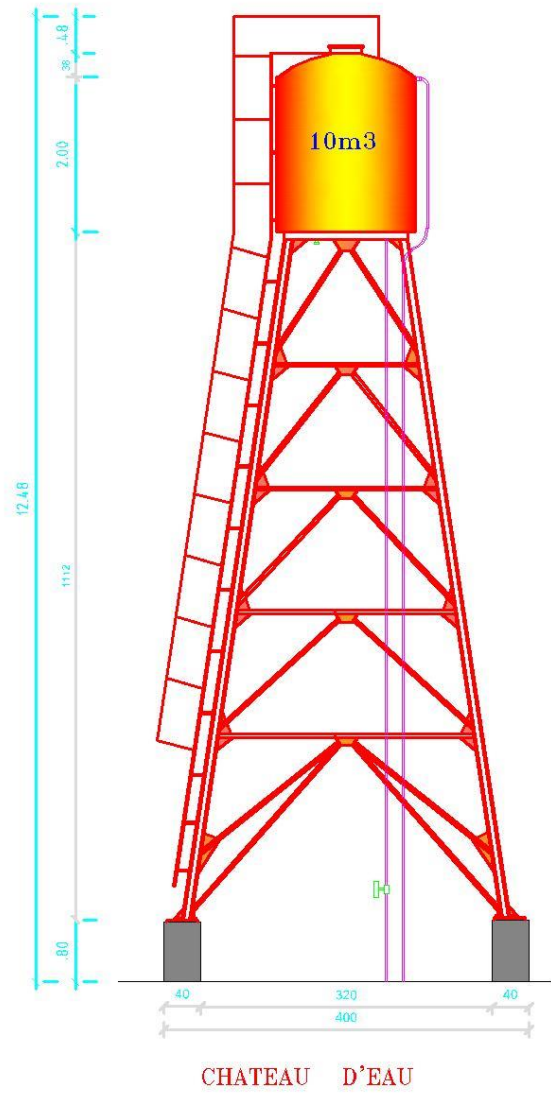

CLOTURE

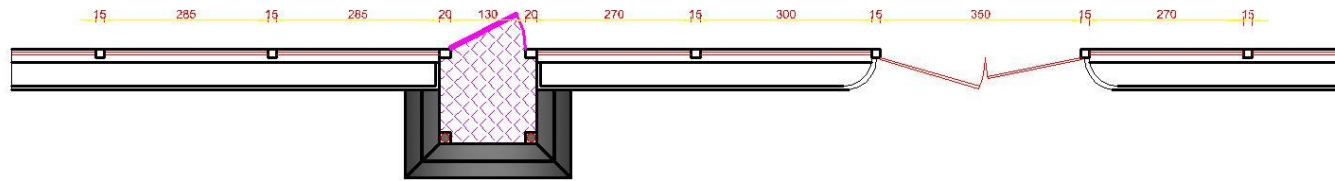

PLAN

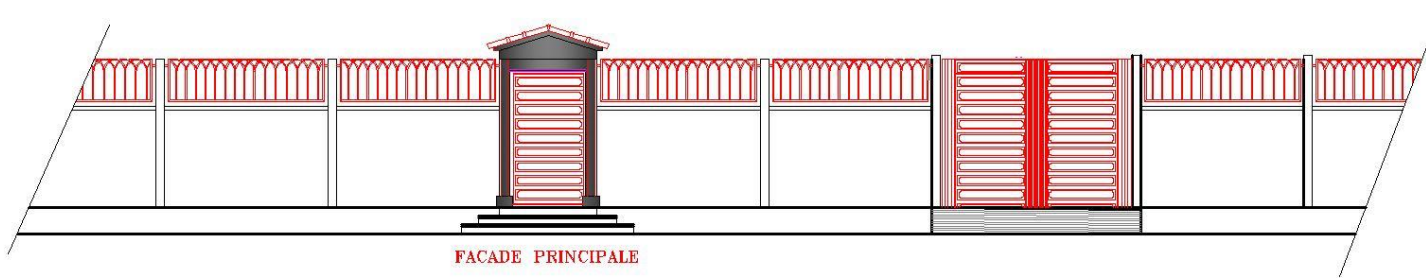

FACADE PRINCIPALE

Banque de Céréale à Karcamba

MAGASIN

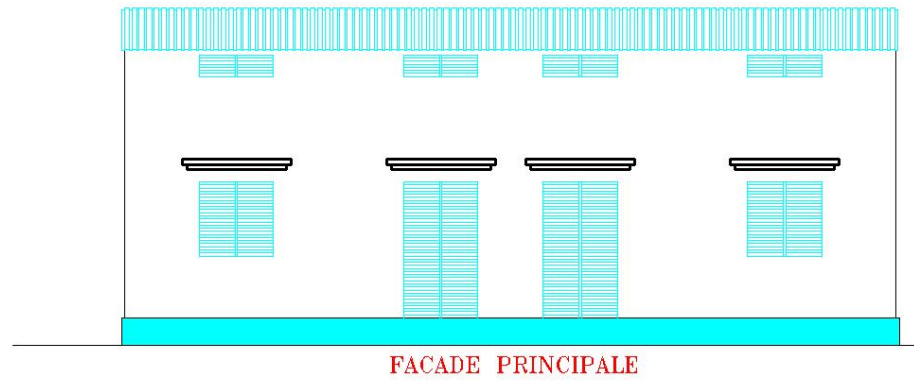
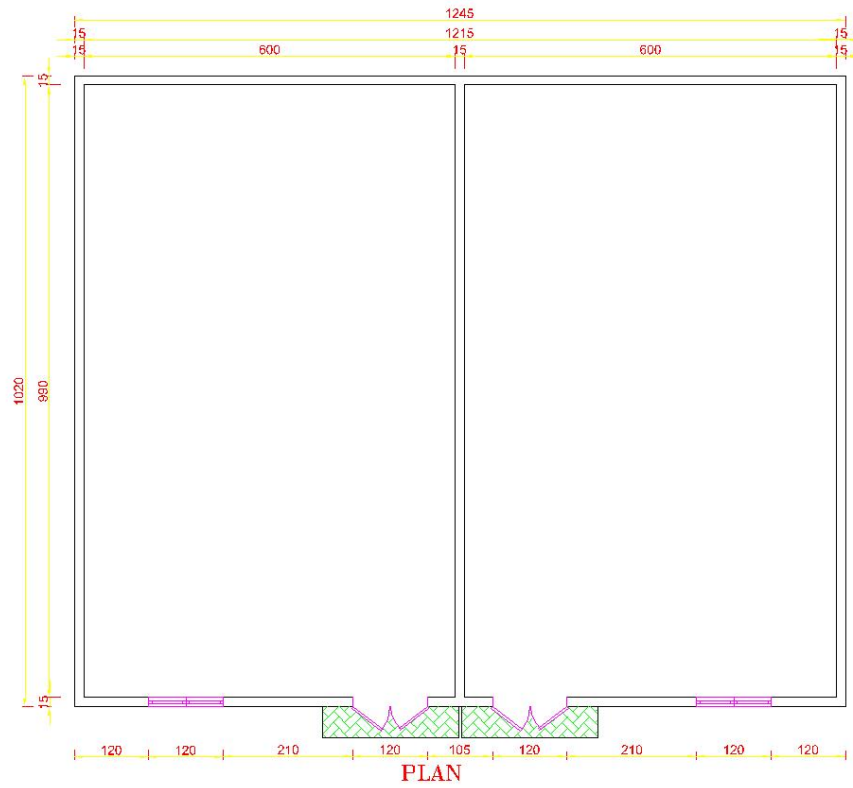

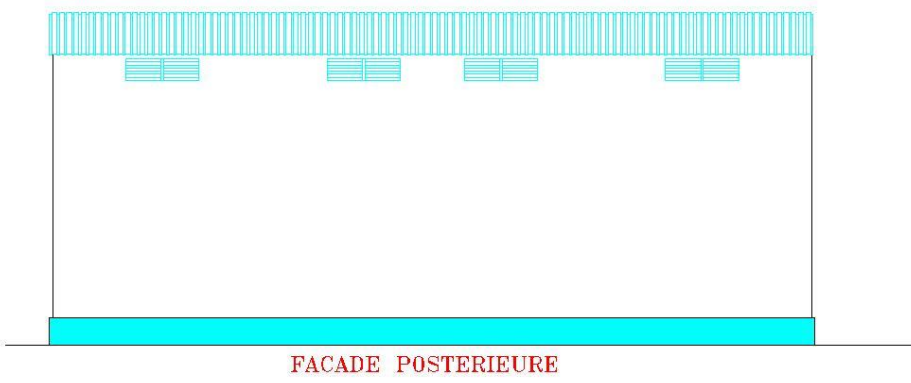
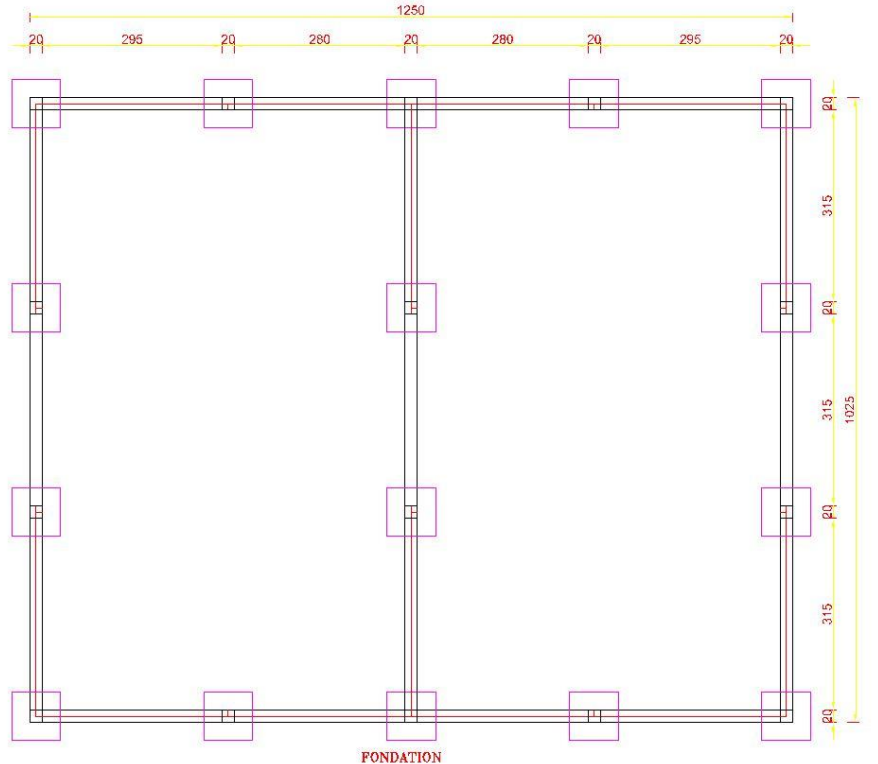

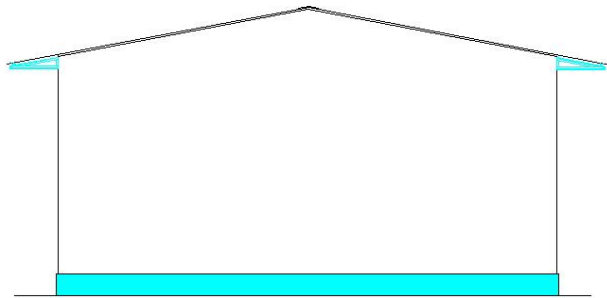

FACADE LATÉRALE MAGASIN

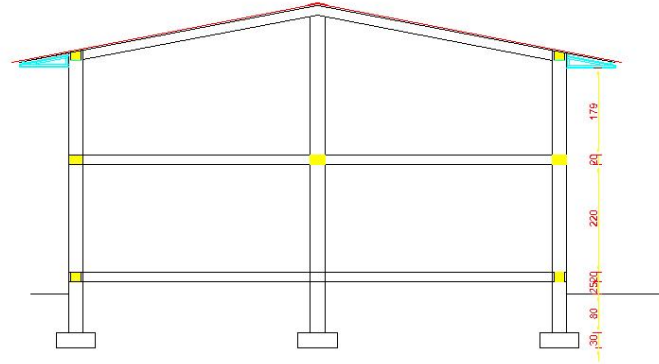

COUPE MAGASIN

CHATEAU D'EAU

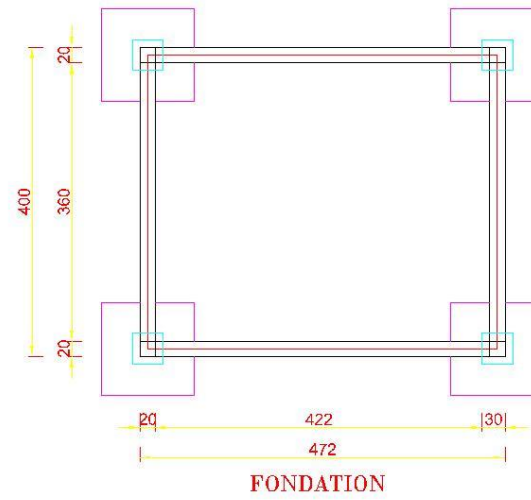
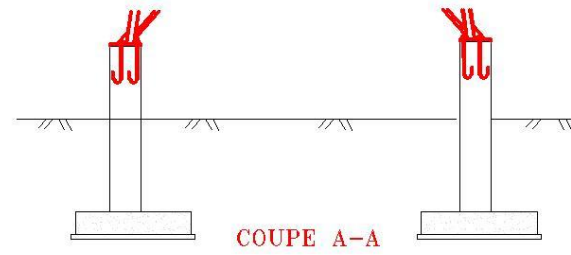
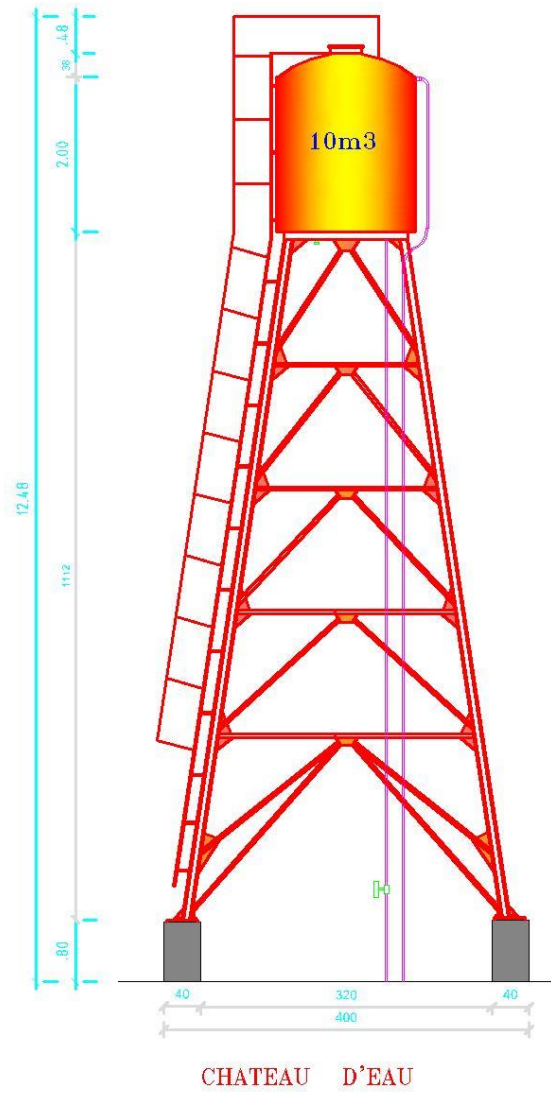

CLOTURE

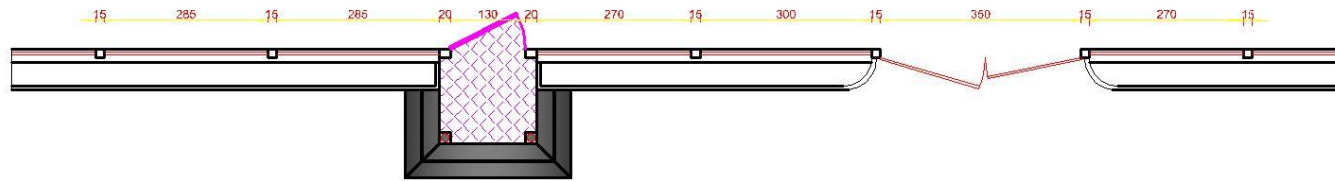

PLAN

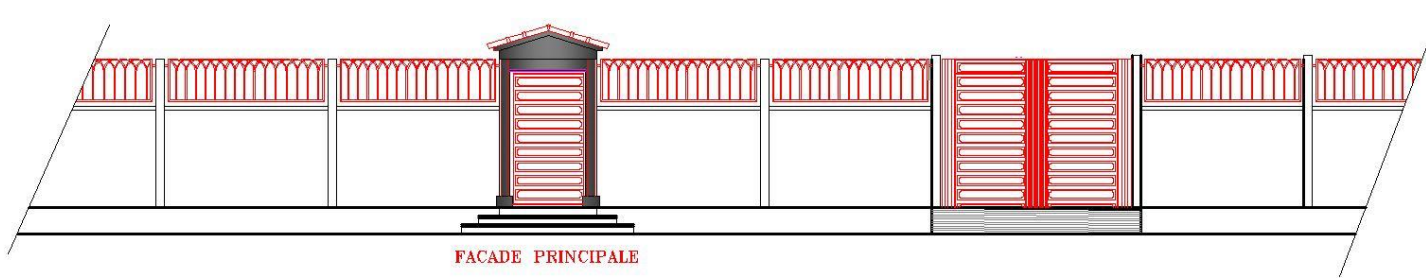

FACADE PRINCIPALE

Centre de collecte et de transformation du lait/mini-laiterie à Ouenkoro

LAITERIE

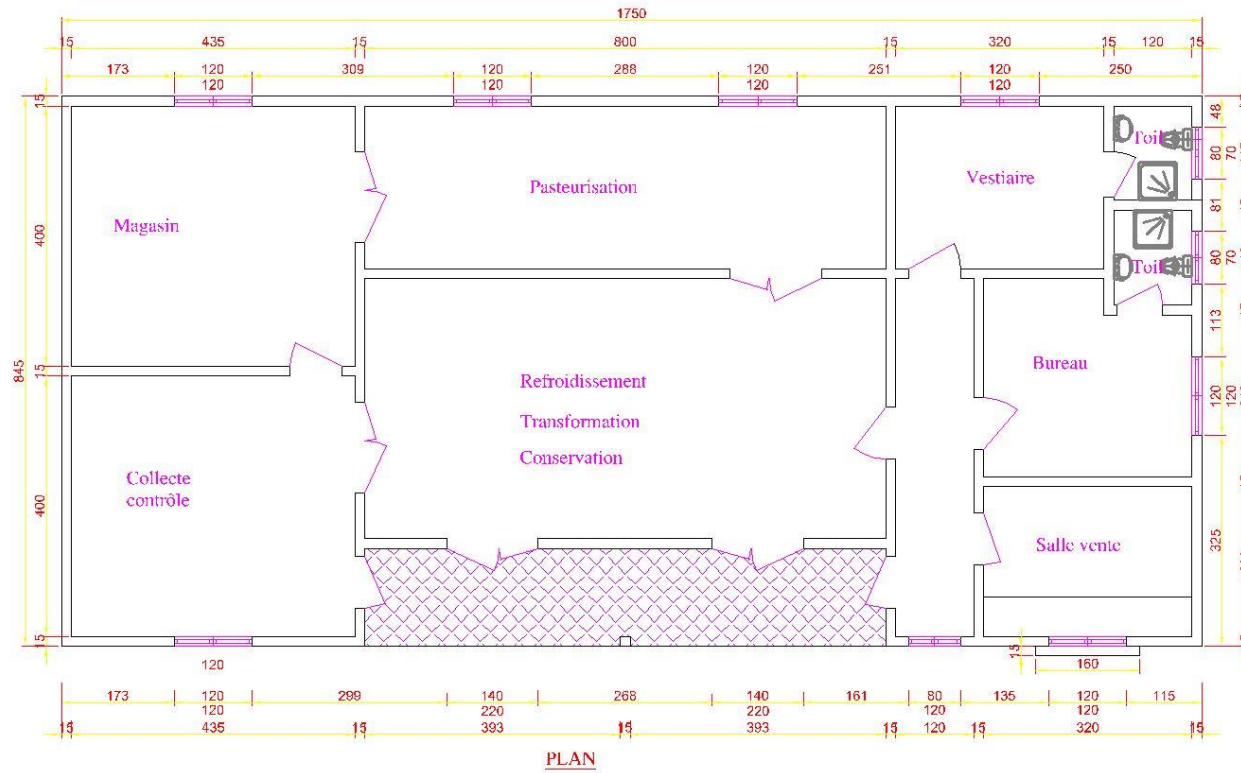

PLAN

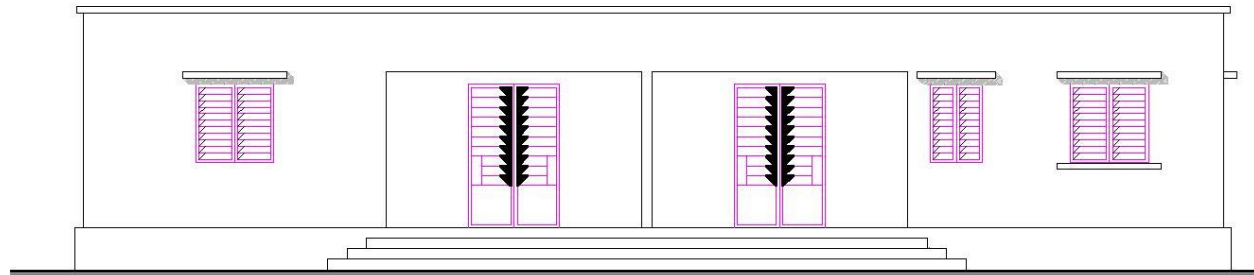

FAÇADE PRINCIPALE

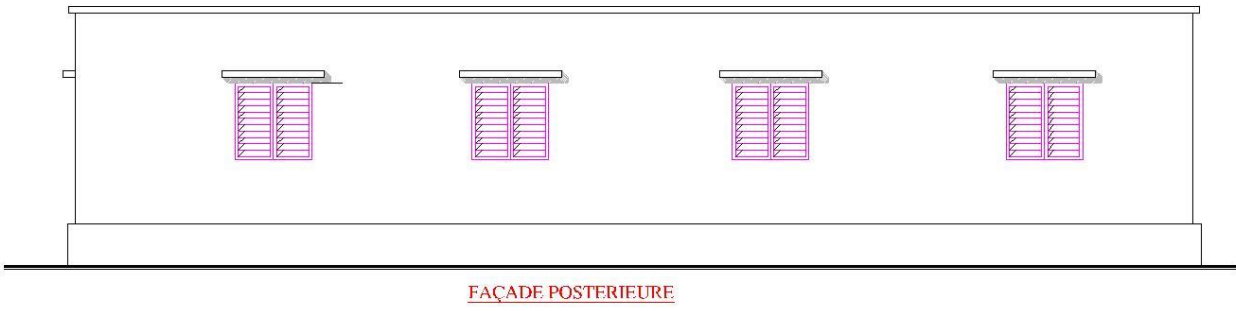
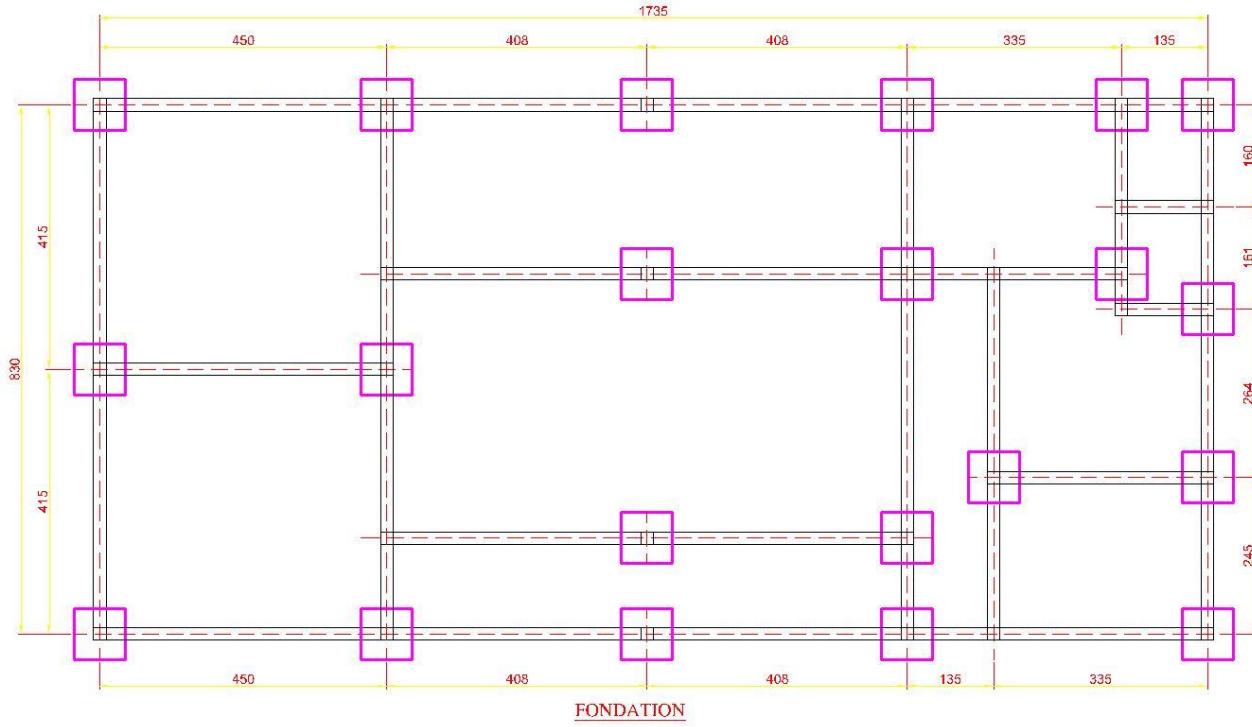

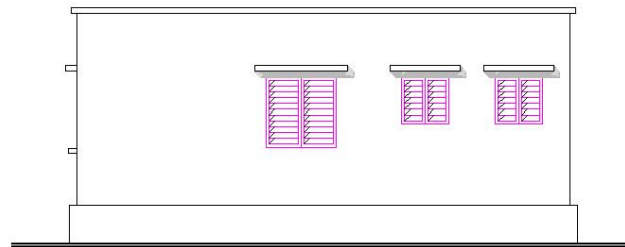

FAÇADE POSTERIEUR

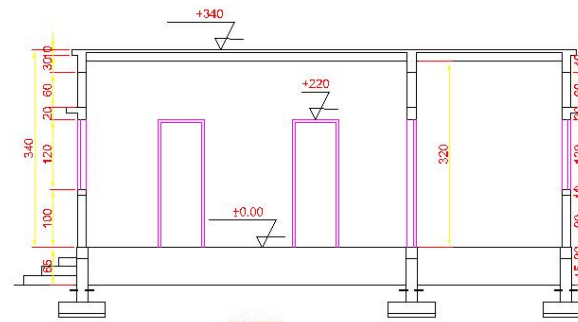

COUPE

TN-65

CHATEAU D'EAU

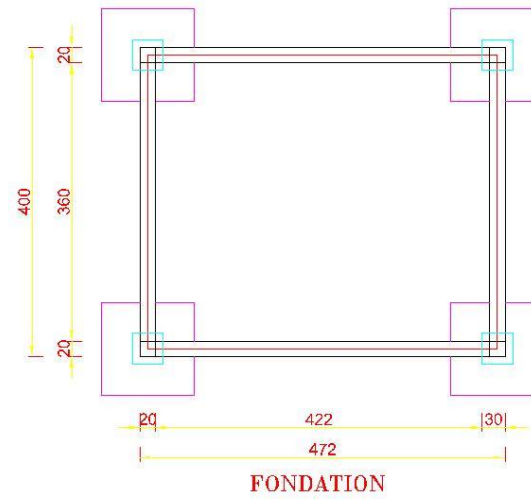
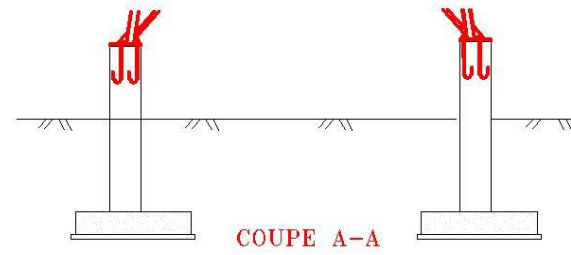
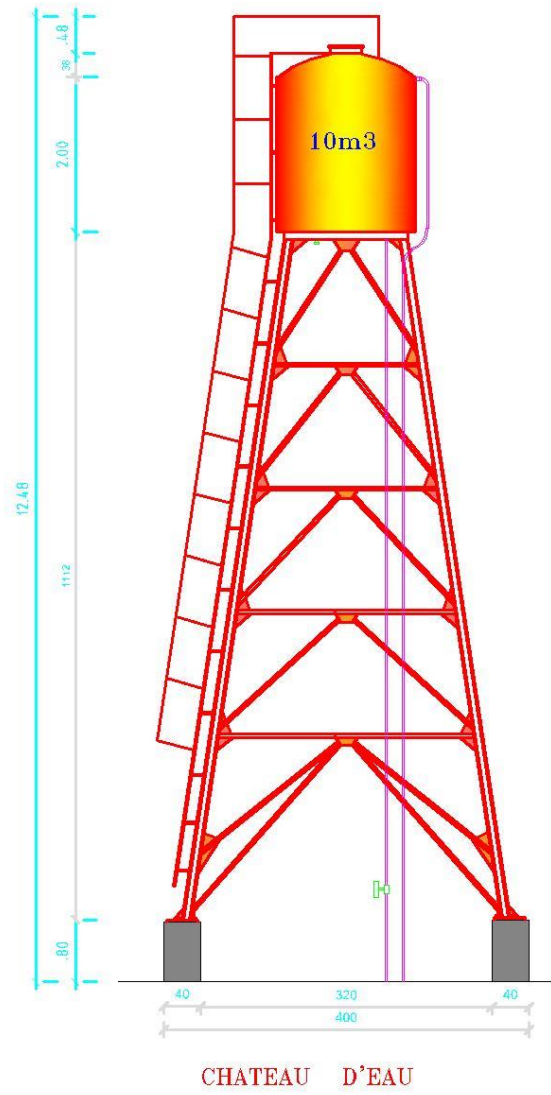

CLOTURE

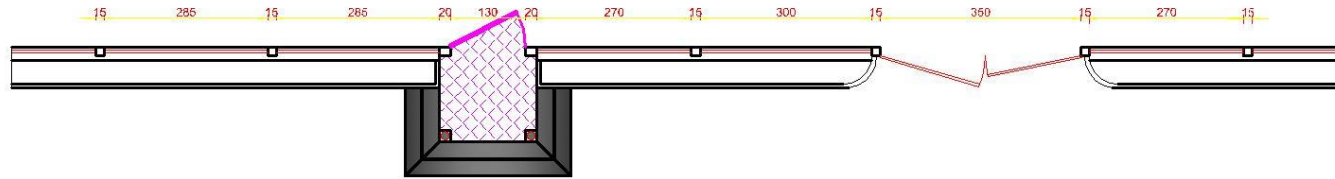

PLAN

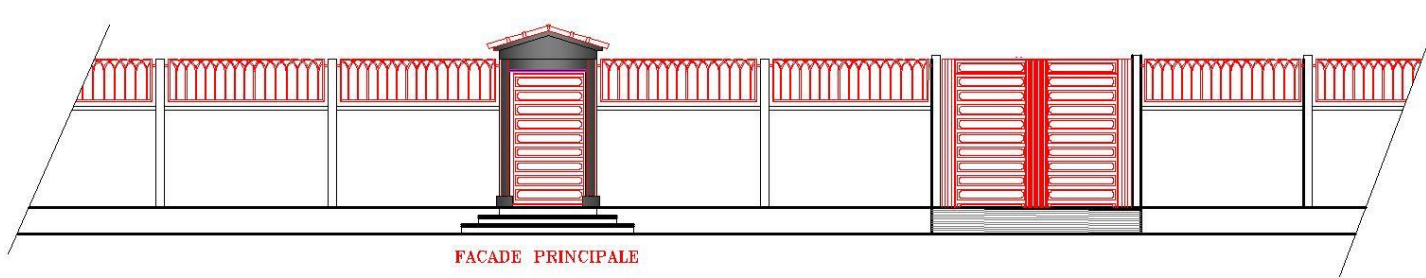

BLOC DE TOILETTE

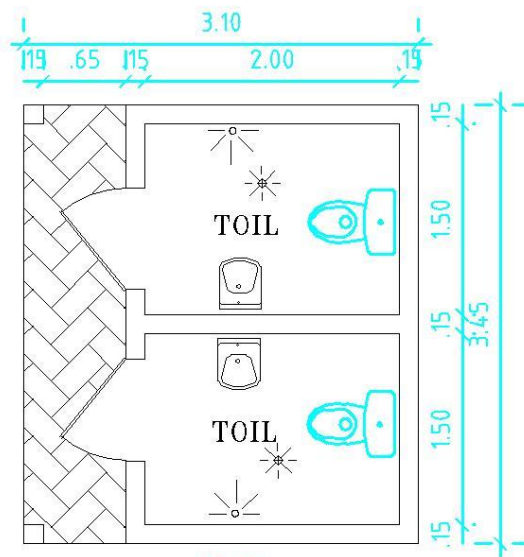

PLAN

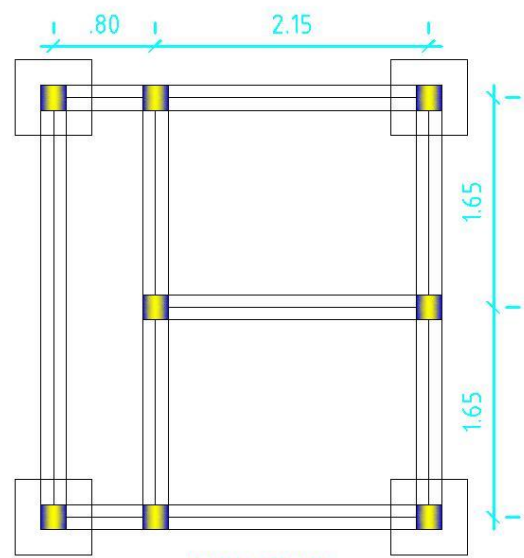

FONDATION

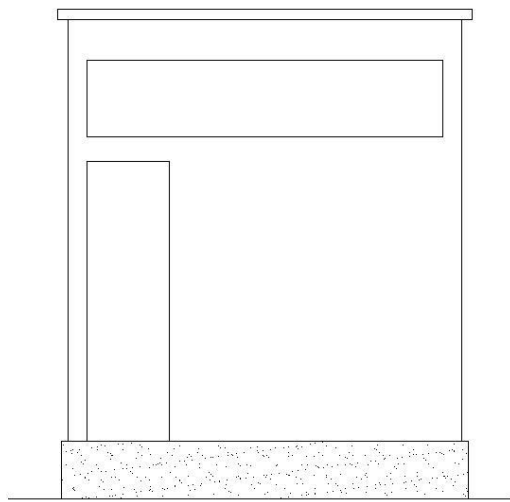

FACADE LATERALE

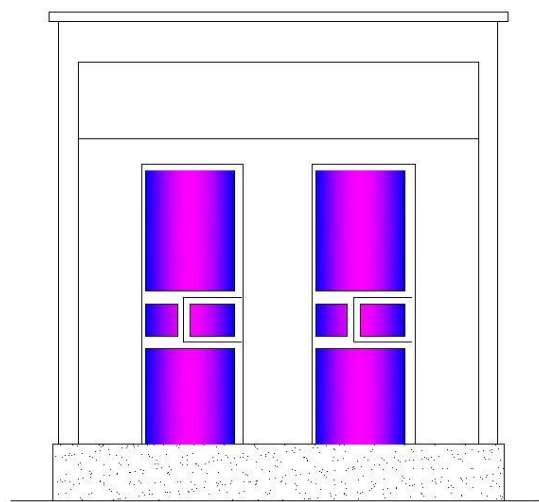

FACADE PRINCIPALE

FOSSE SEPTIQUE

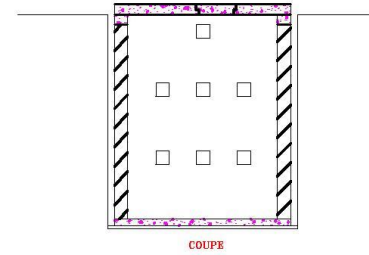
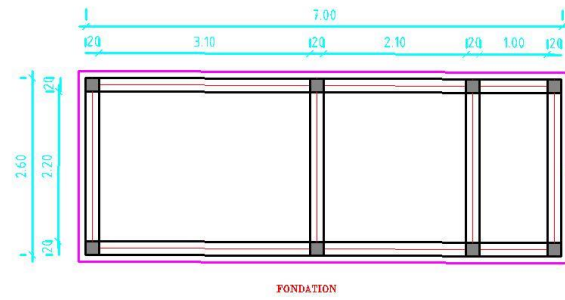
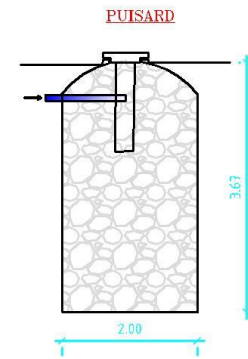
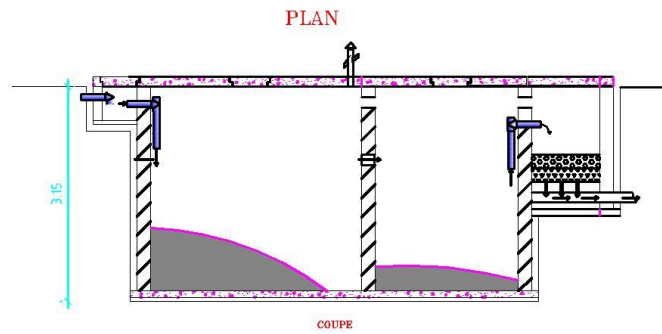
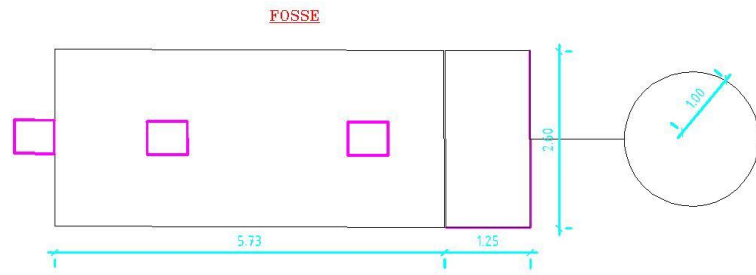

LOGEMENT DU GARDIEN

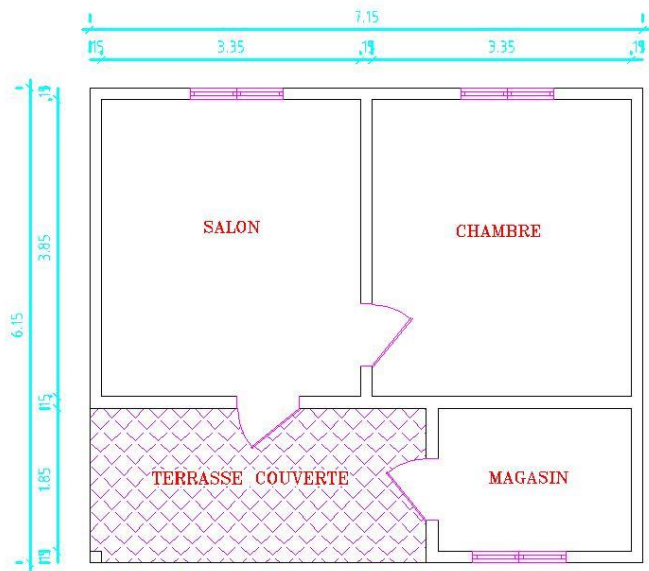

PLAN

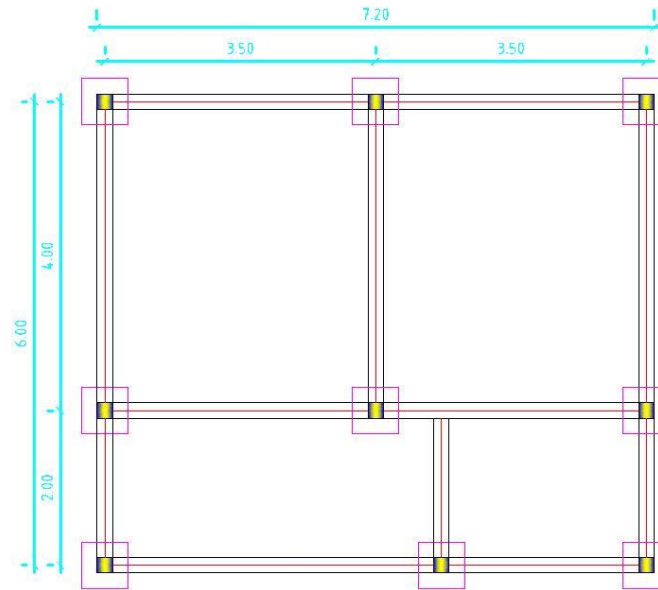

FONDATION

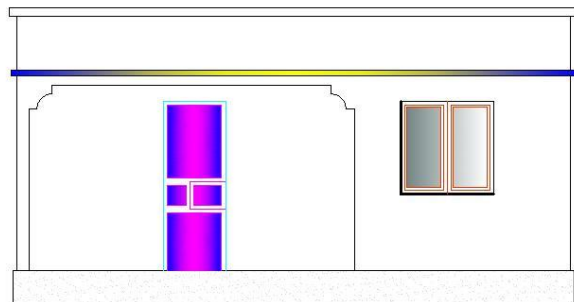

FACADE PRINCIPALE

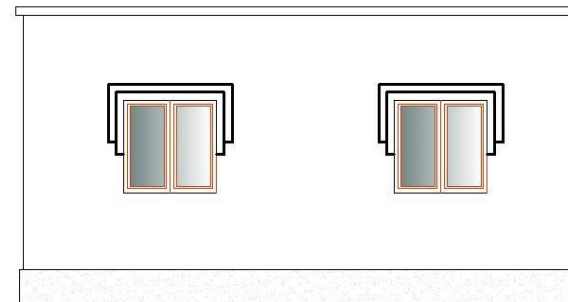

FACADE POSTERIEURE

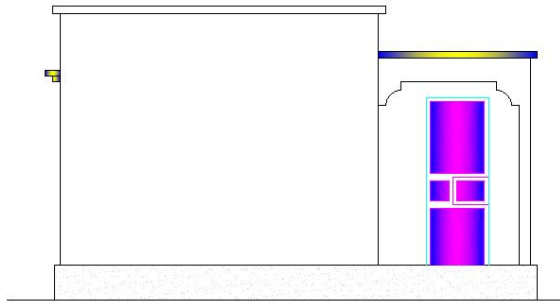

FACADE LATÉRALE DROITE

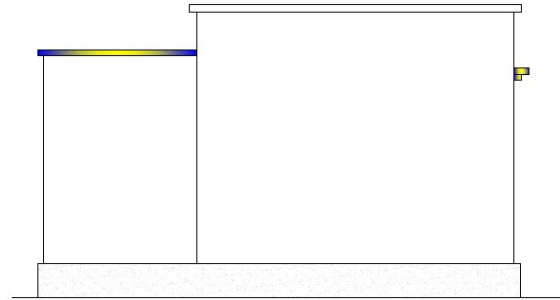

FACADE LATÉRALE DROITE

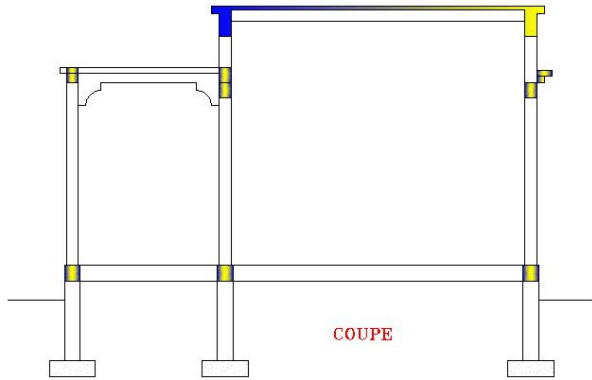

COUPE

BLOC DE CUISINE EXTERIEURE

Cuisine exterieure / J17

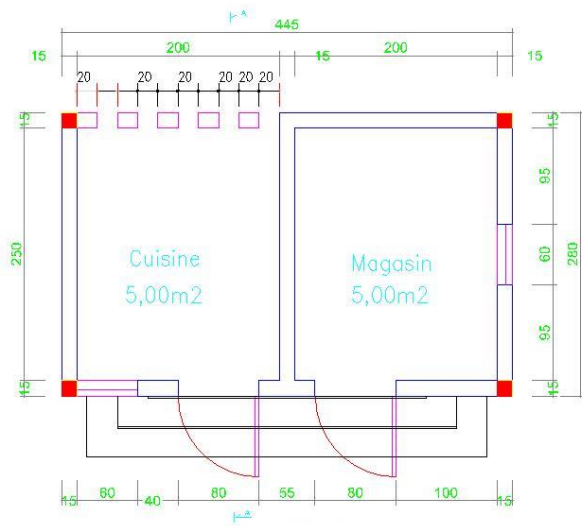

PLAN

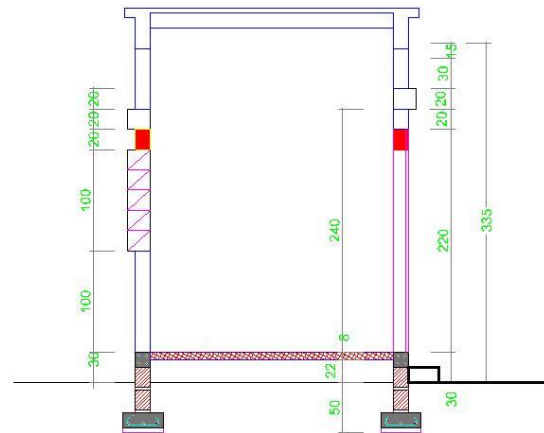

COUPE AA

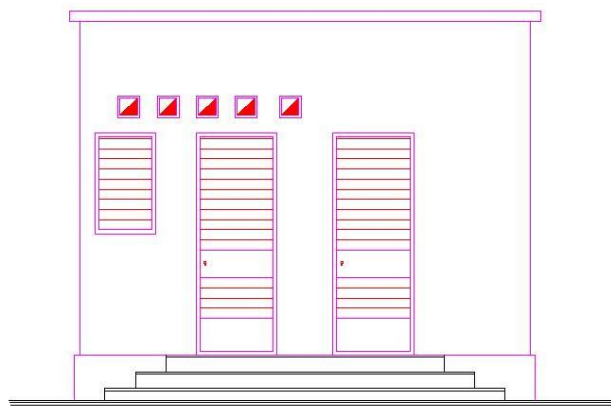

FAÇADE

LOT I

Magasin stockage des produits maraichers à Barani

MAGASIN DE STOCKAGE

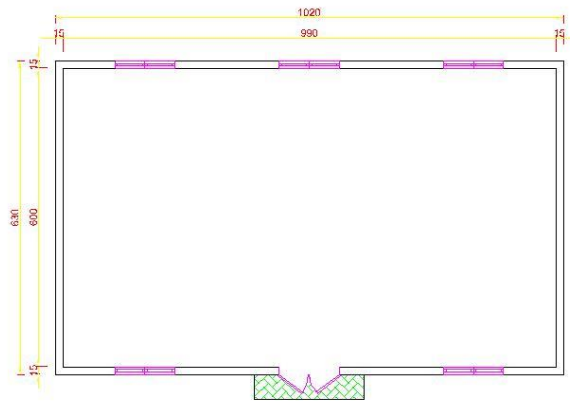

PLAN

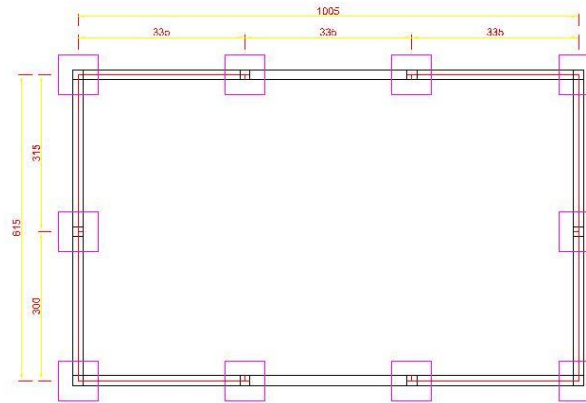

FONDATION

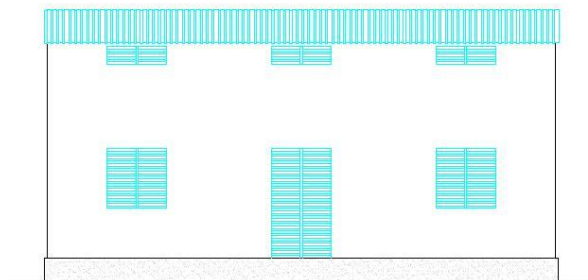

FACADE PRINCIPALE

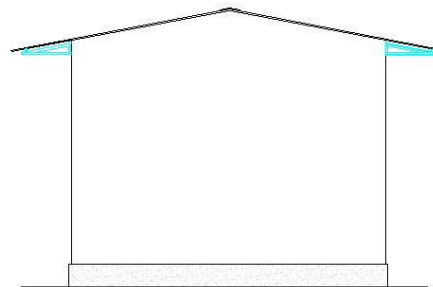

FACADE LATERALE

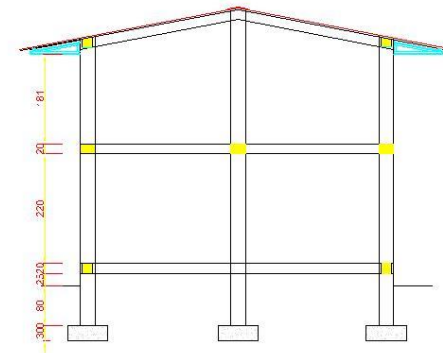

COUPE

CHATEAU D'EAU

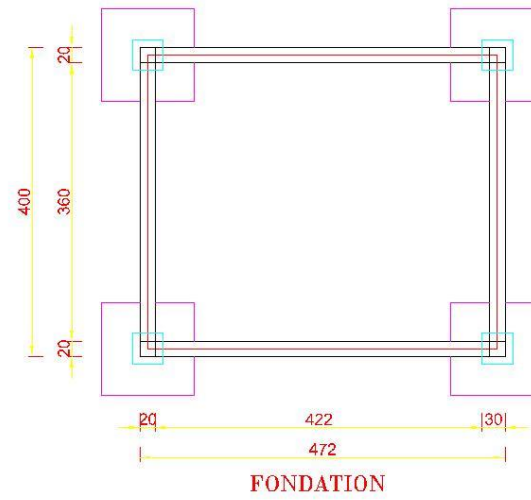
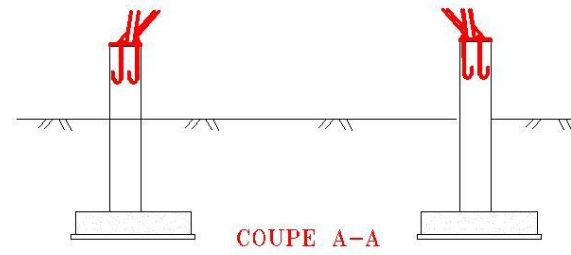
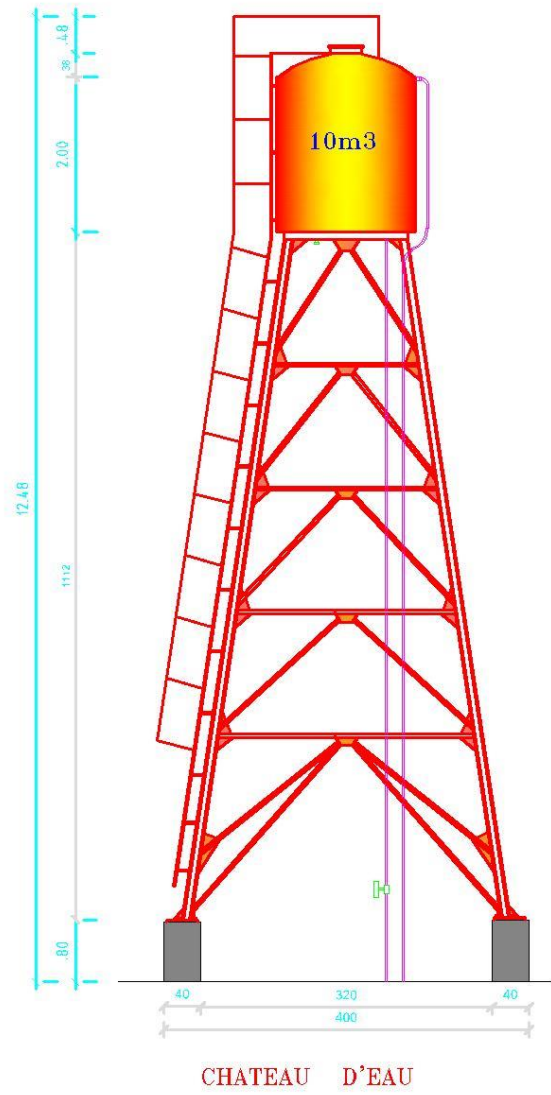

CLOTURE

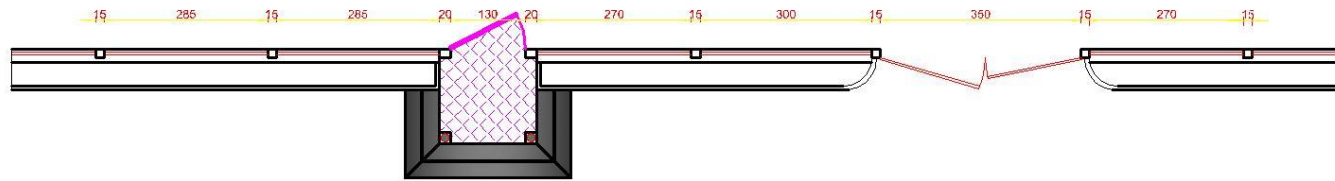

PLAN

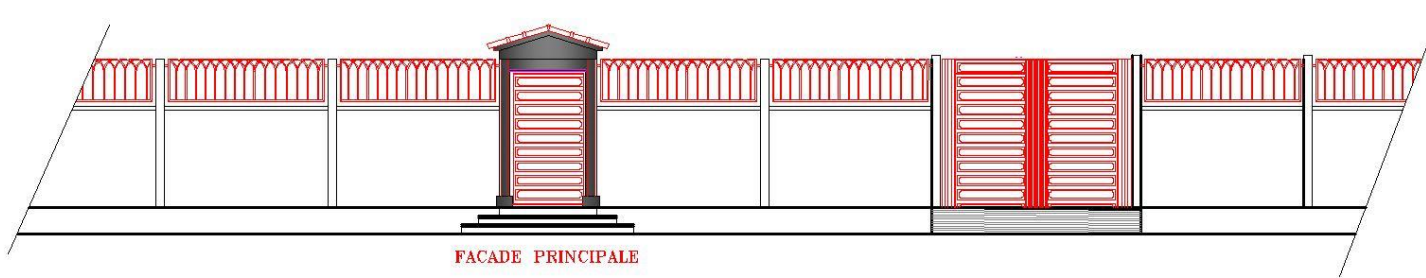

Banque de Céréale à Toeni

MAGASIN

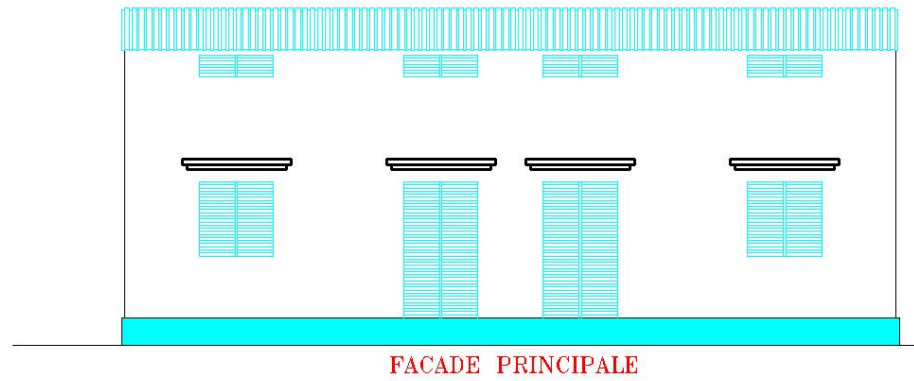
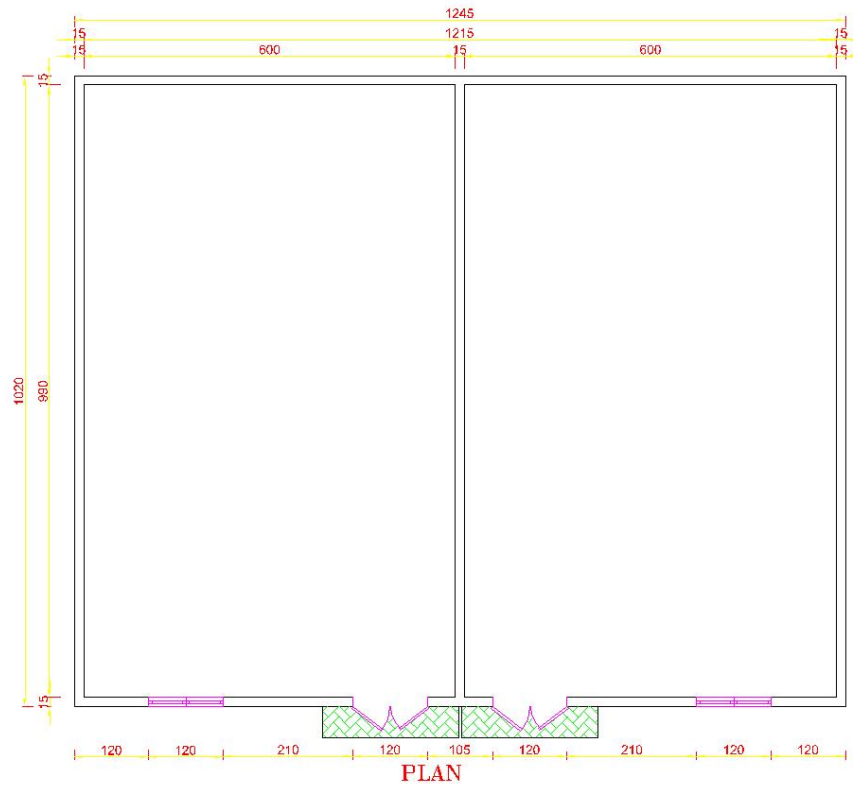

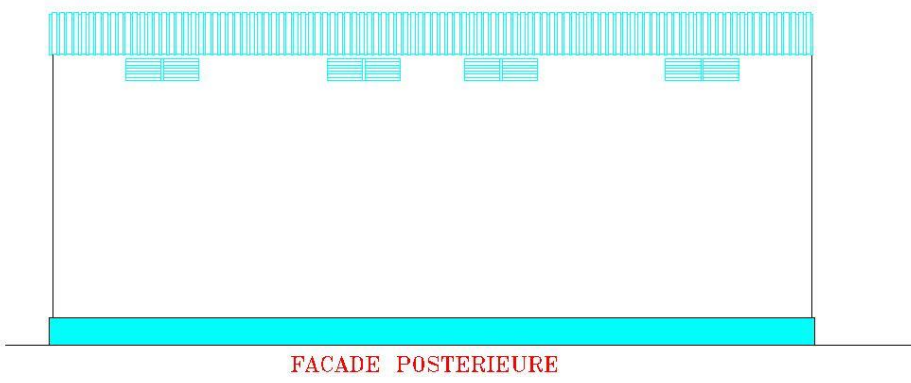
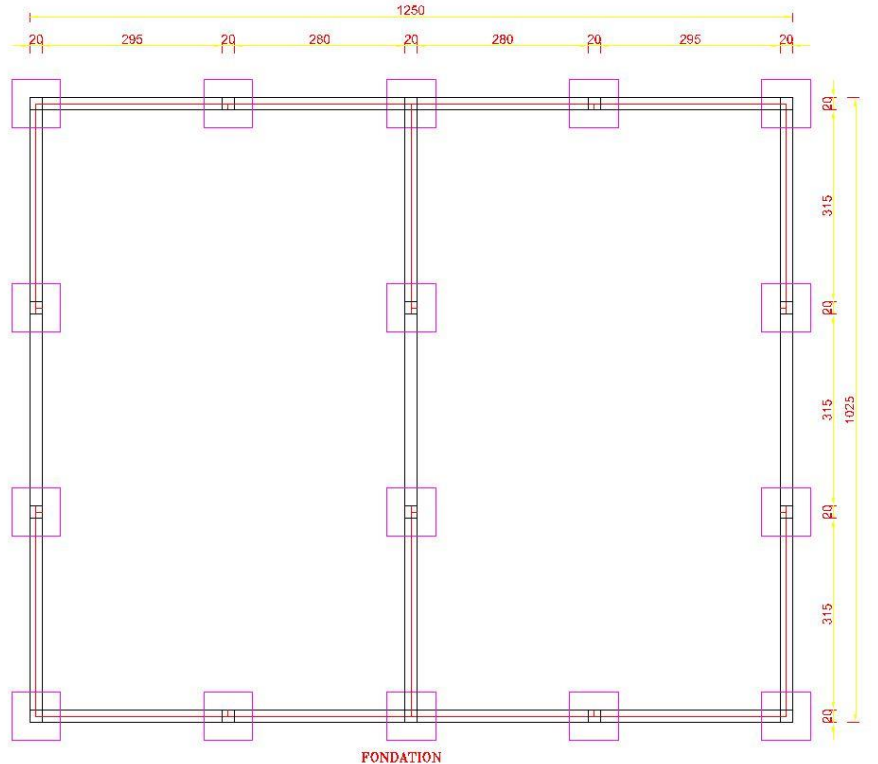

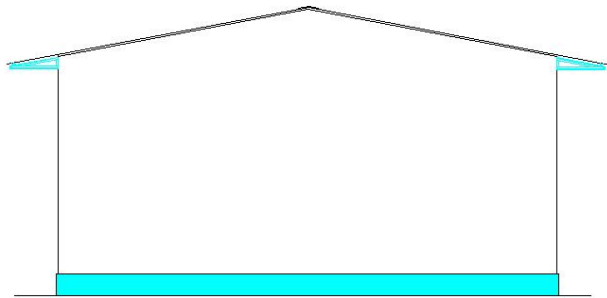

FACADE LATÉRALE MAGASIN

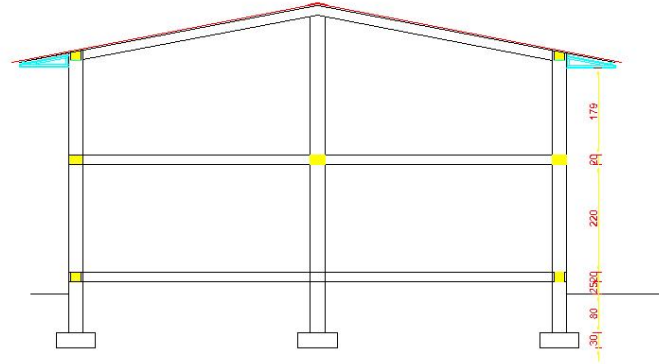

COUPE MAGASIN

CHATEAU D'EAU

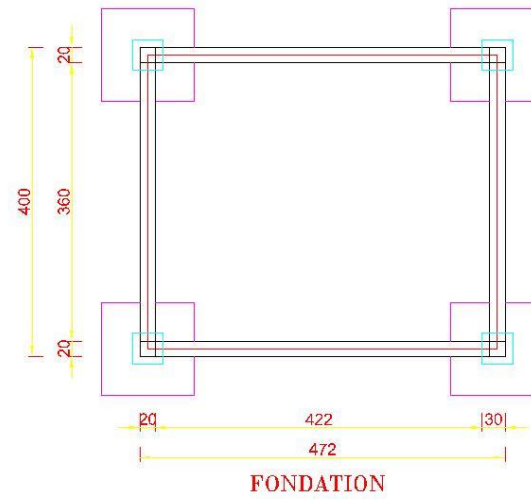
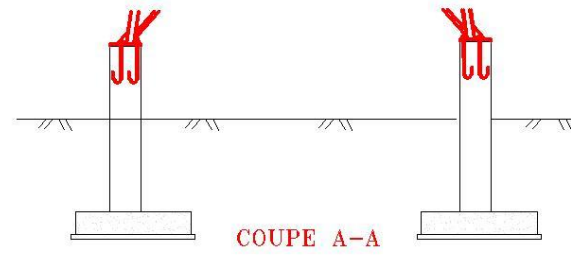
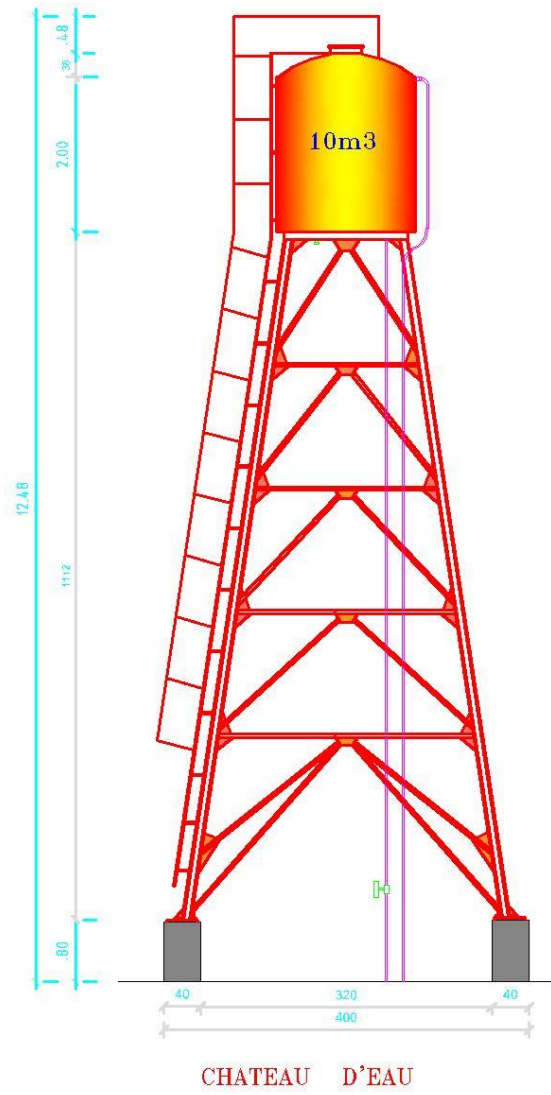

CLOTURE

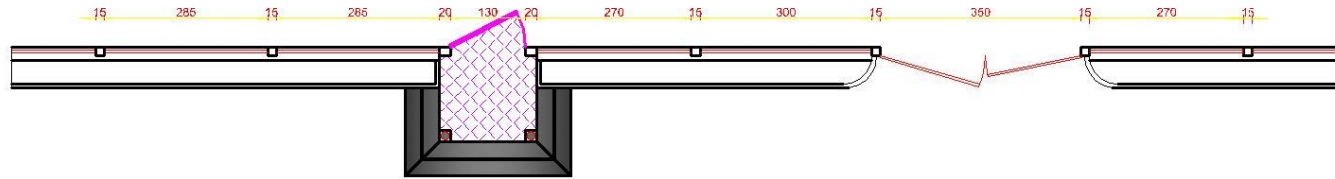

PLAN

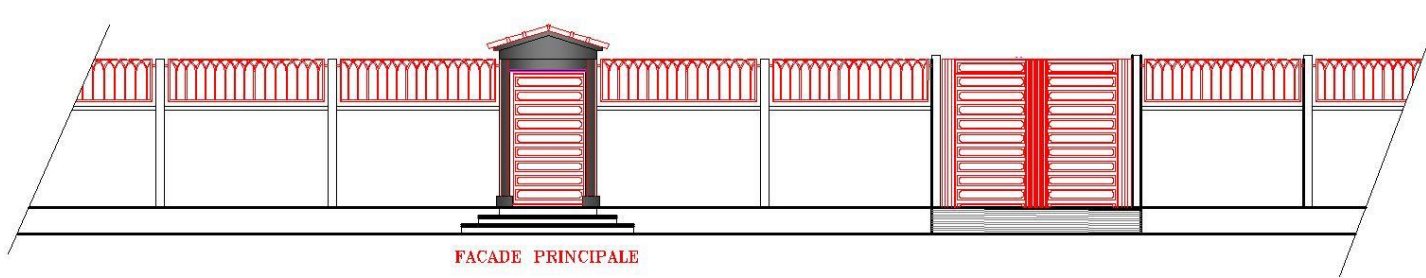

FACADE PRINCIPALE

Centre de collecte et de transformation du lait/mini-laiterie à DI

LAITERIE

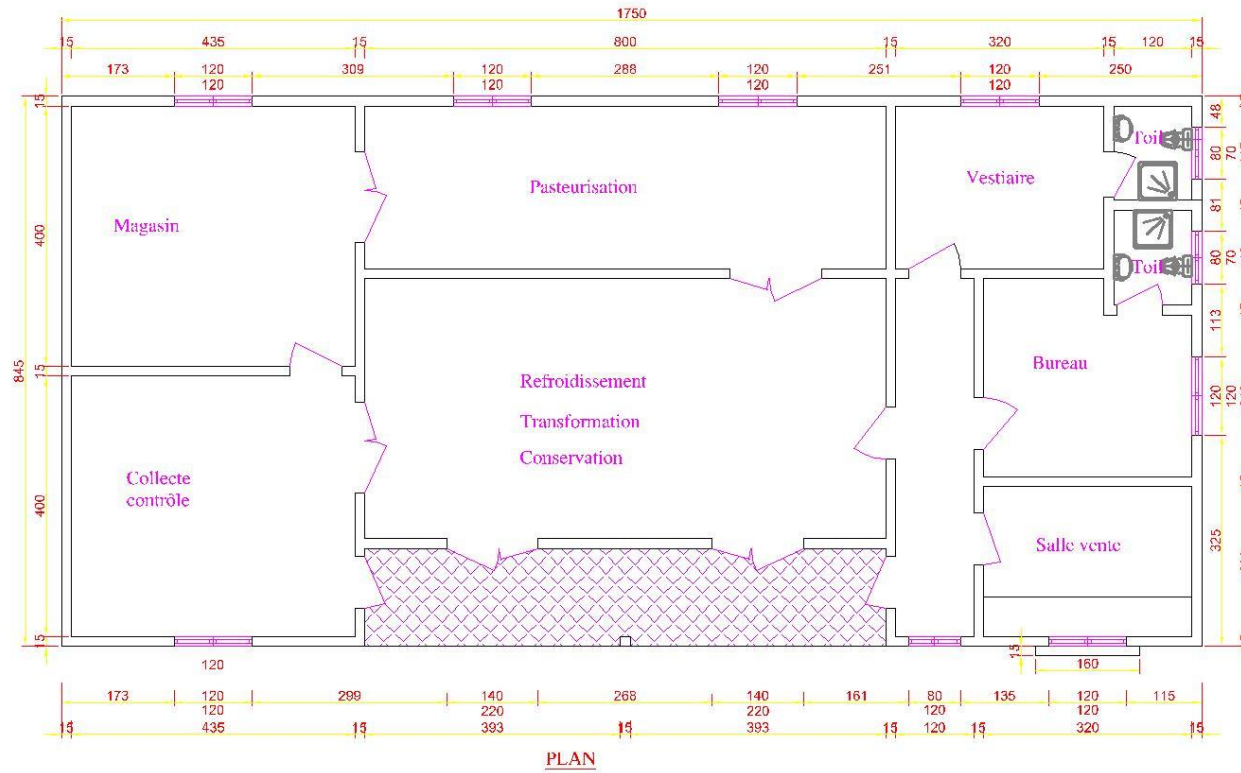

PLAN

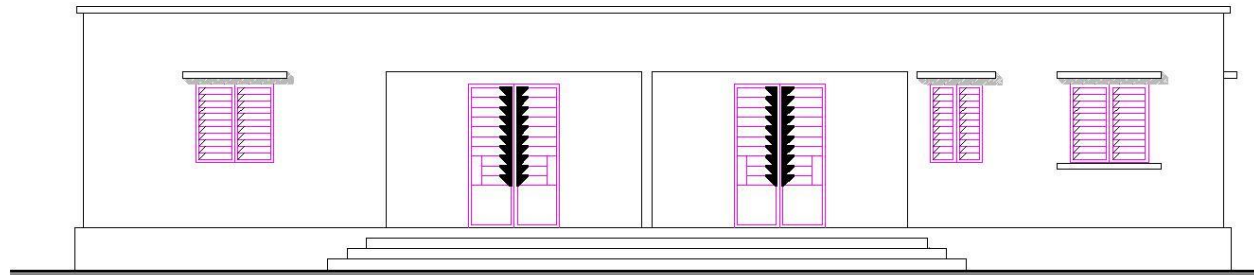

FAÇADE PRINCIPALE

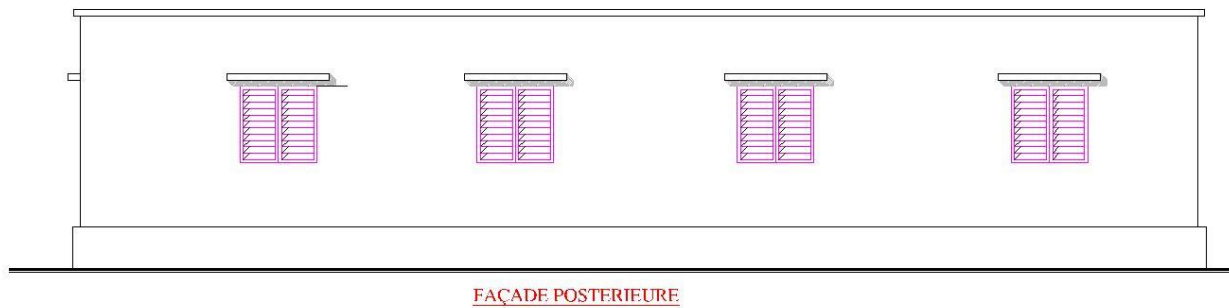
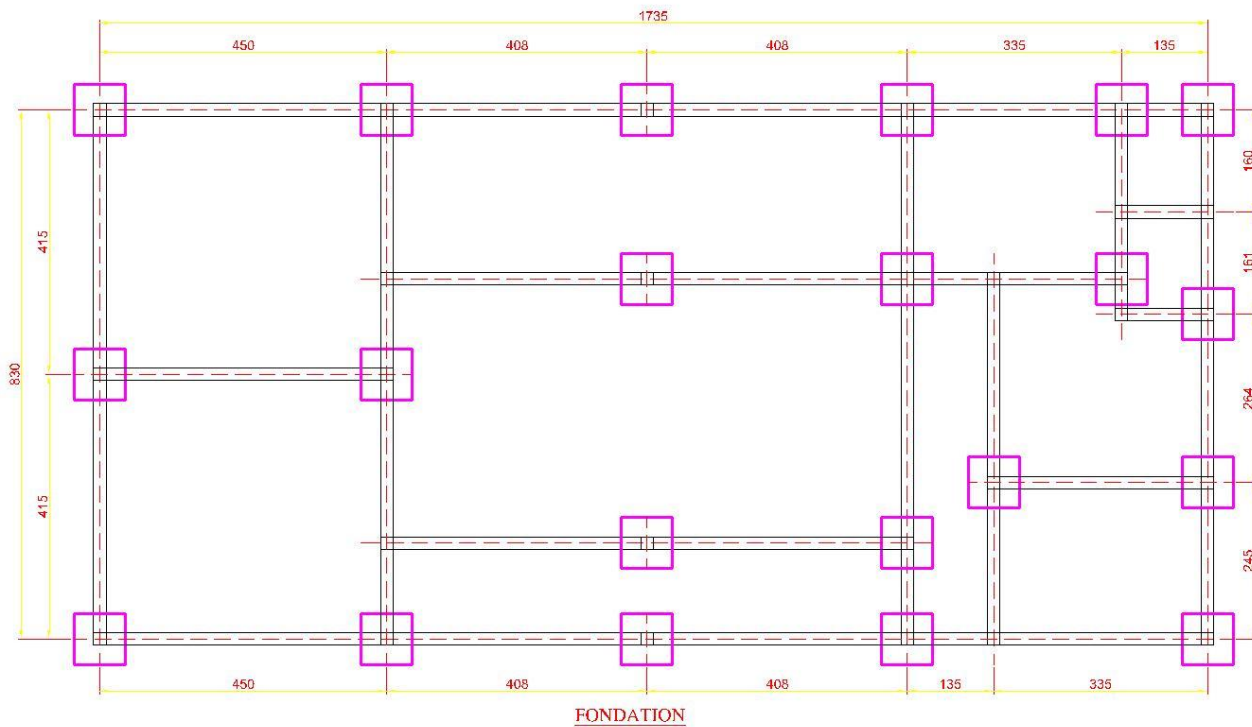

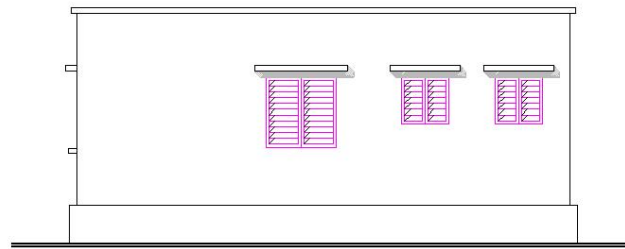

FAÇADE POSTERIEUR

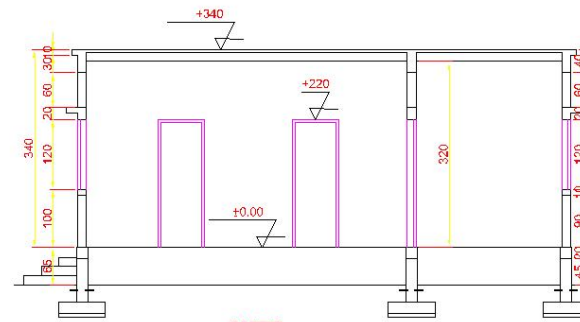

COUPE

TN-65

CHATEAU D'EAU

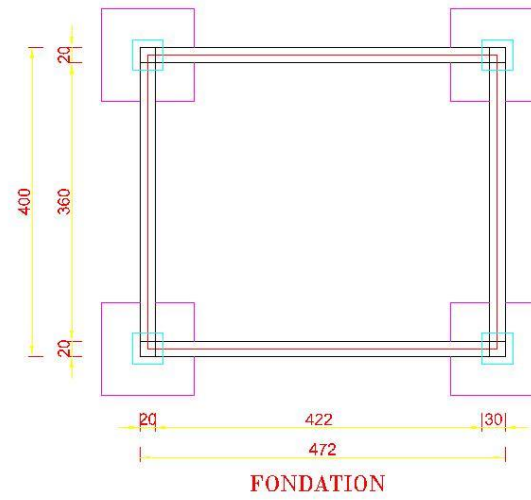
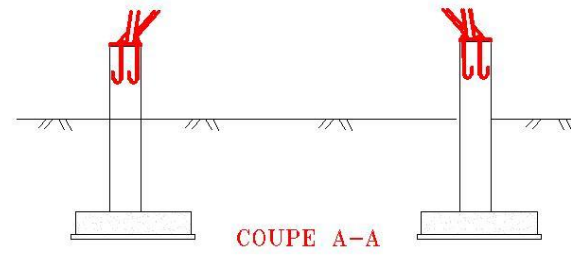
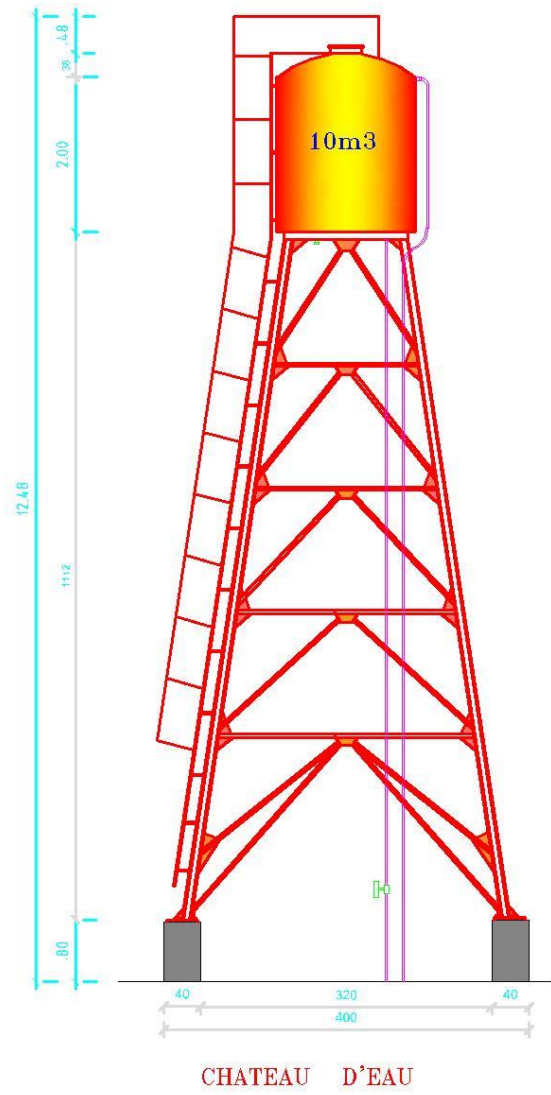

CLOTURE

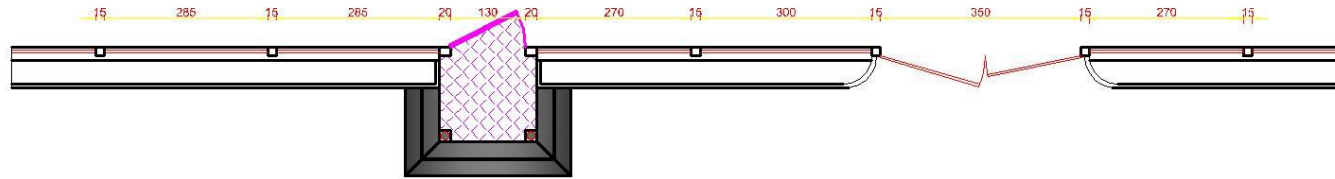

PLAN

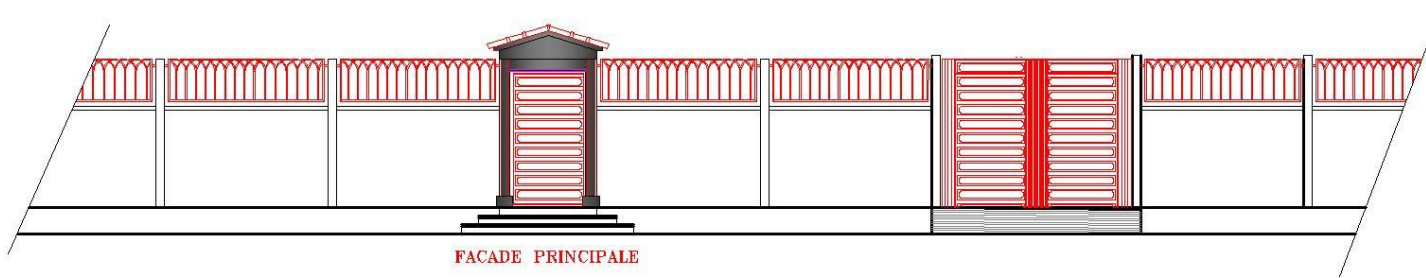

BLOC DE TOILETTE

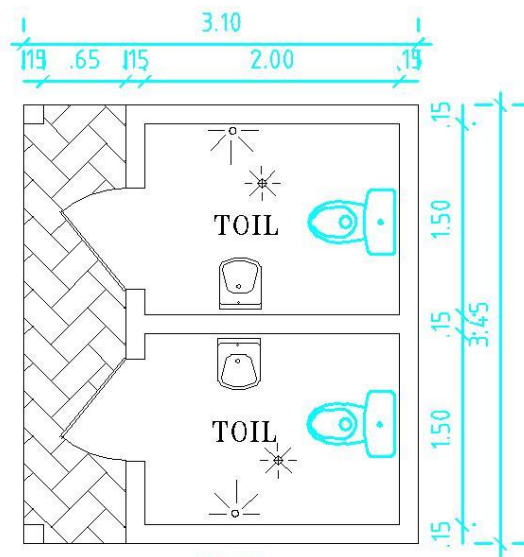

PLAN

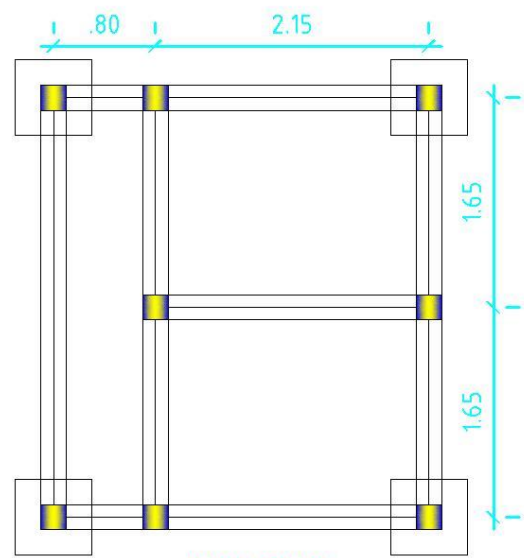

FONDATION

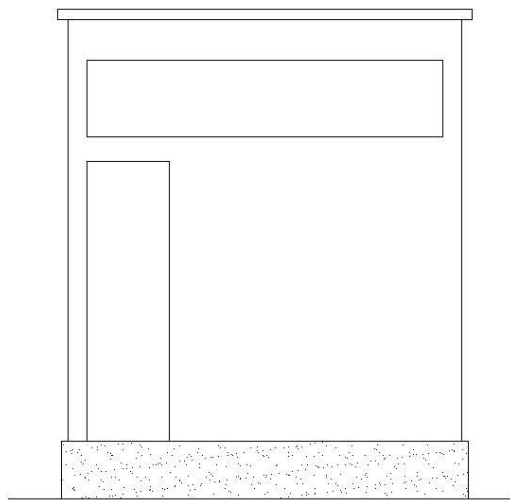

FACADE LATERALE

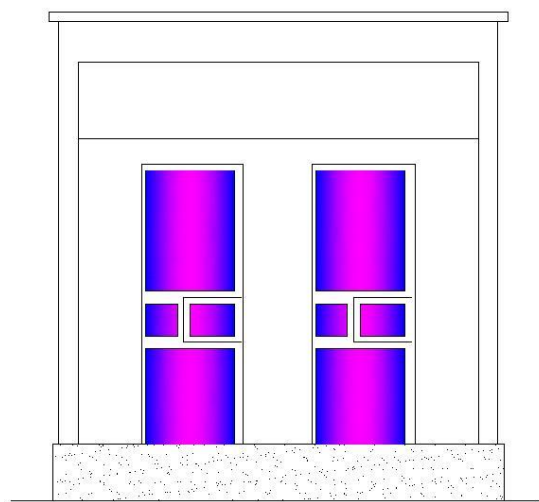

FACADE PRINCIPALE

FOSSE SEPTIQUE

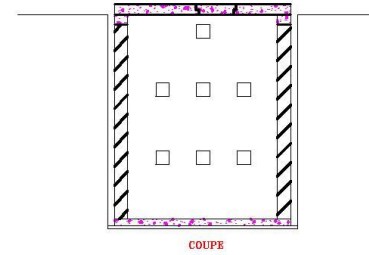
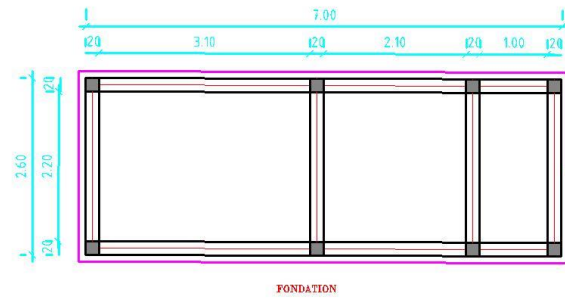
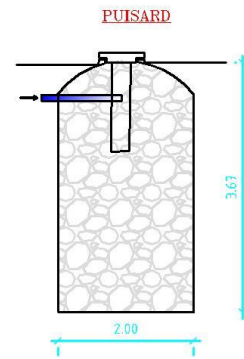
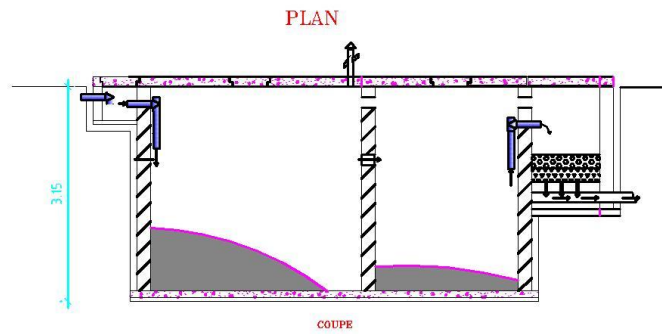
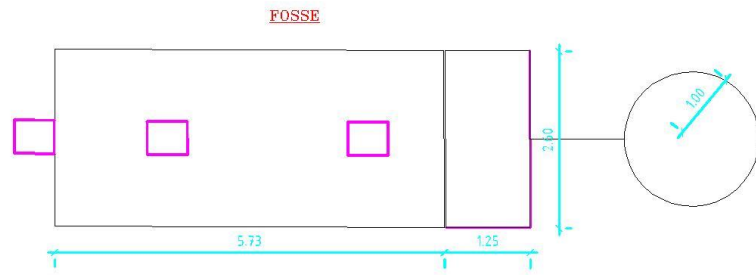

LOGEMENT DU GARDIEN

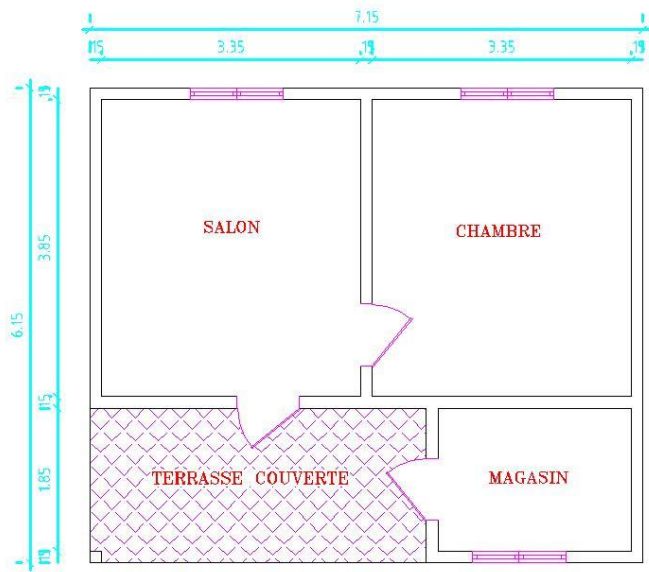

PLAN

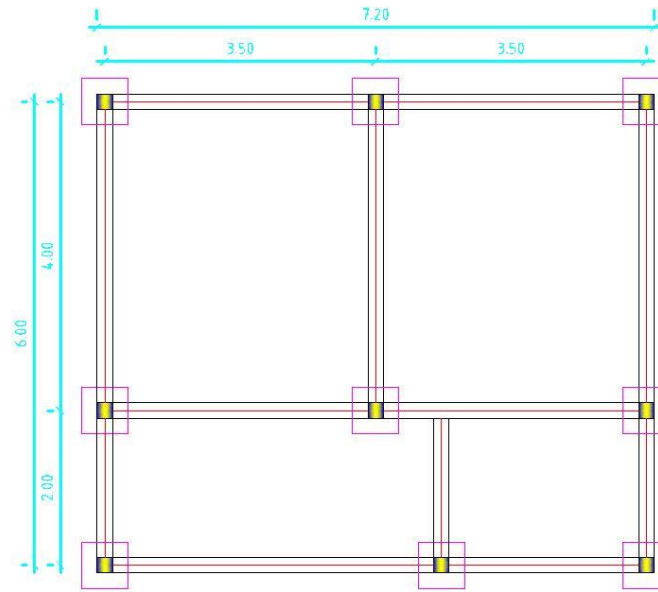

FONDATION

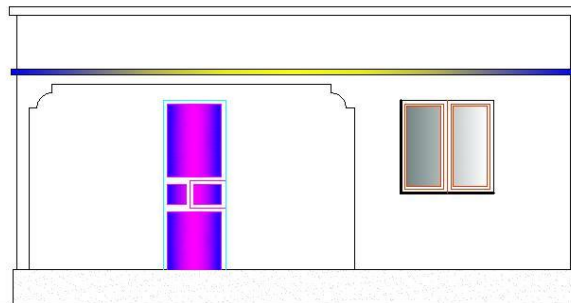

FACADE PRINCIPALE

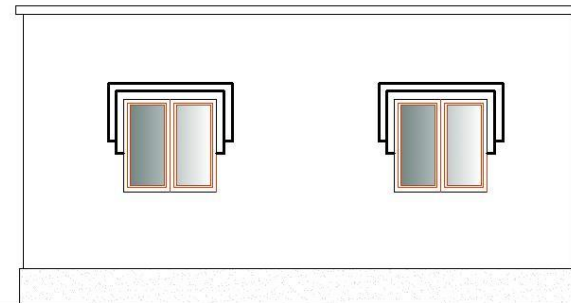

FACADE POSTERIEURE

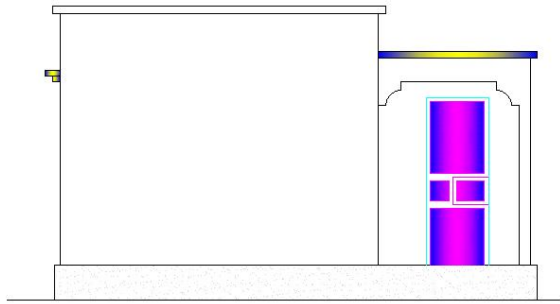

FACADE LATÉRALE DROITE

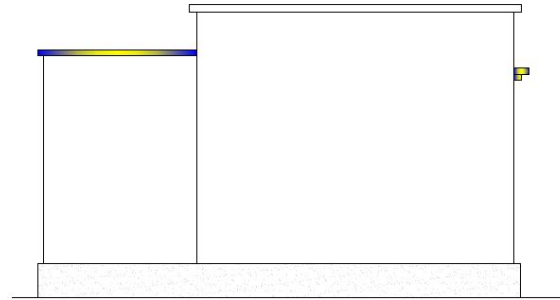

FACADE LATÉRALE DROITE

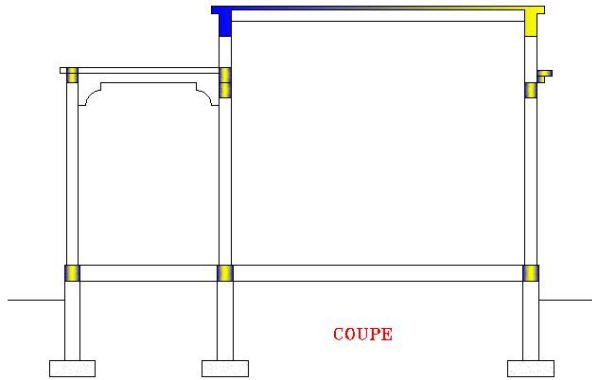

COUPE

BLOC DE CUISINE EXTERIEURE

Cuisine exterieure / J17

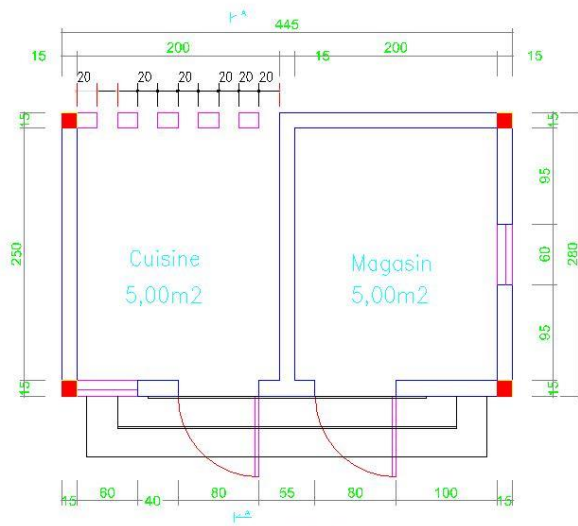

PLAN

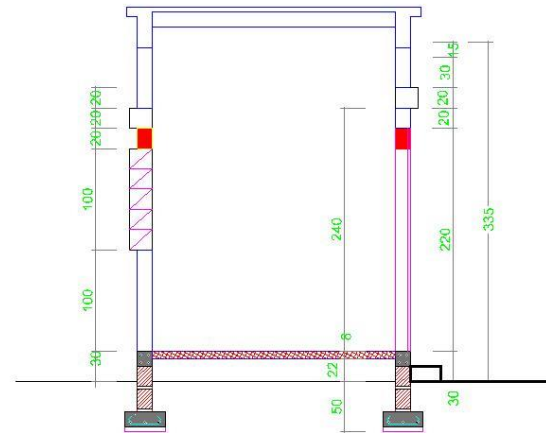

COUPE AA

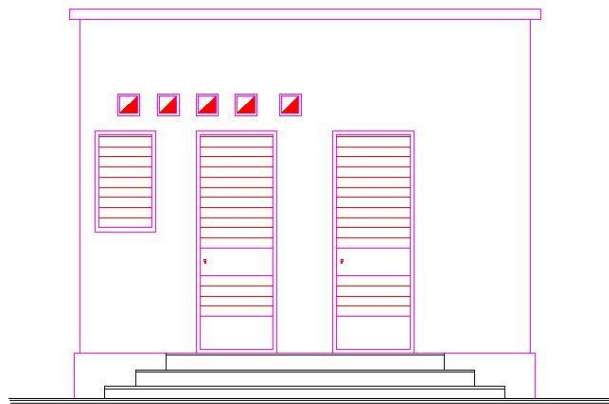

FAÇADE

ALEVINIERE A DI

ECLOSERIE

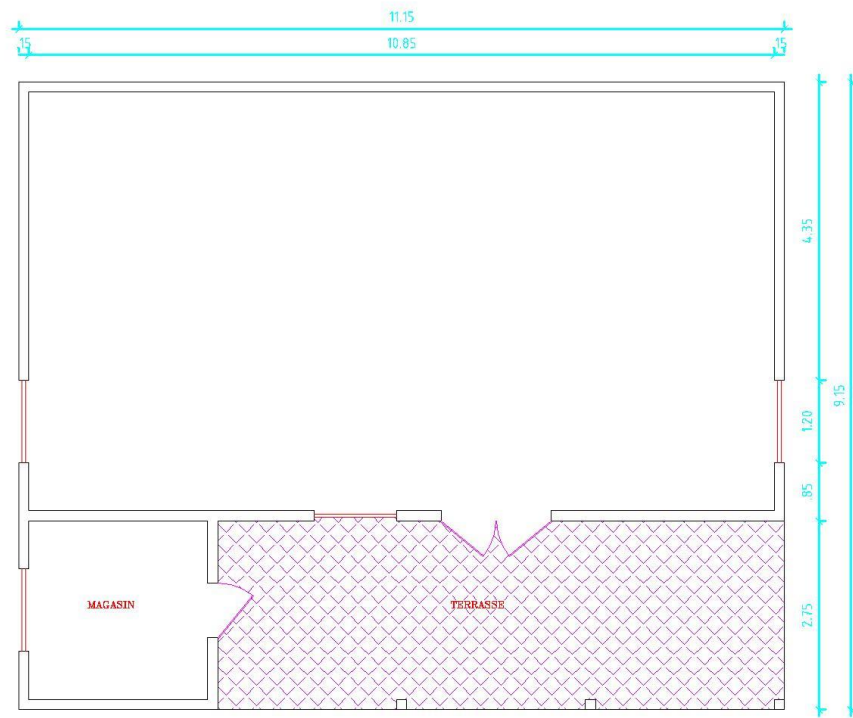

PLAN

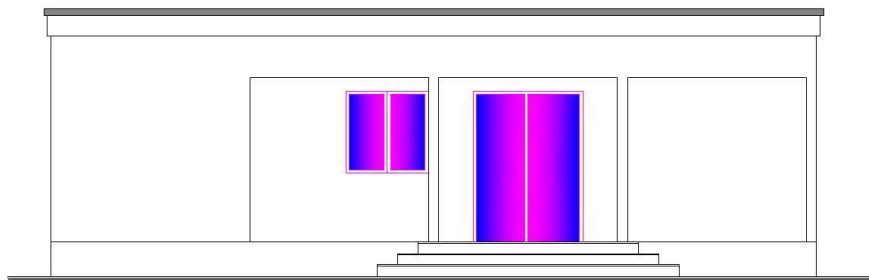

FACADE PRINCIPALE

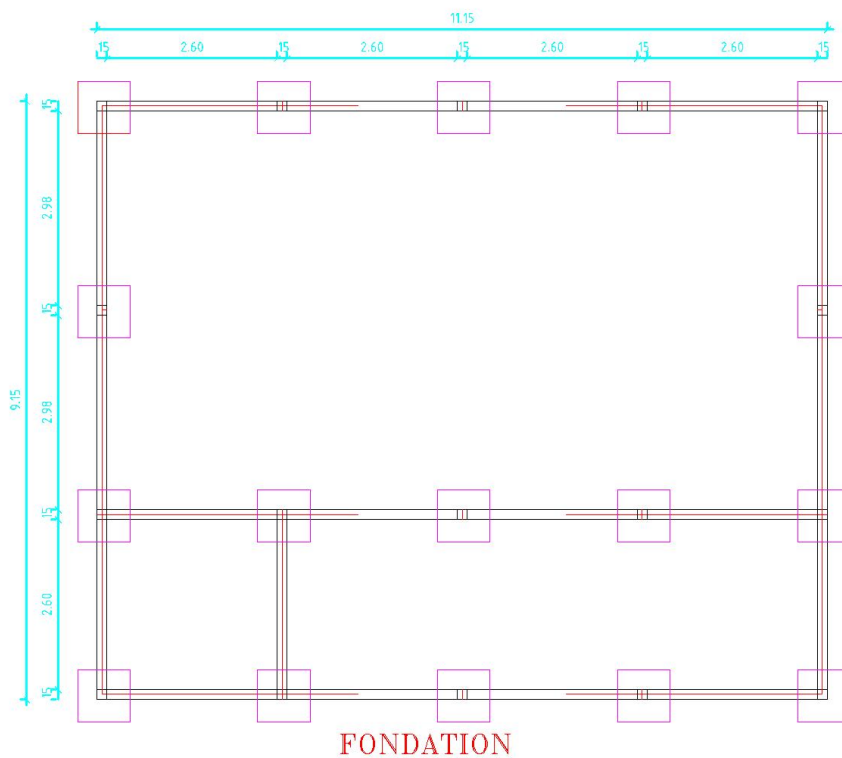

FONDATION

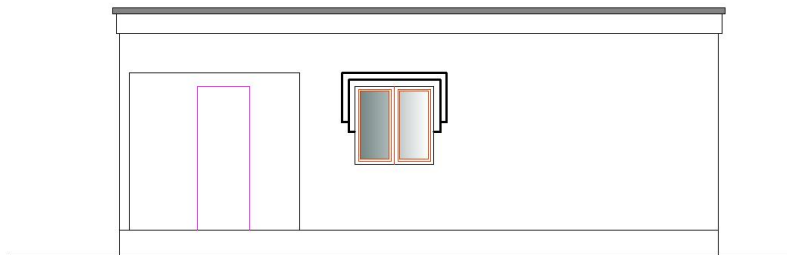

FACADE LATERALE DROITE

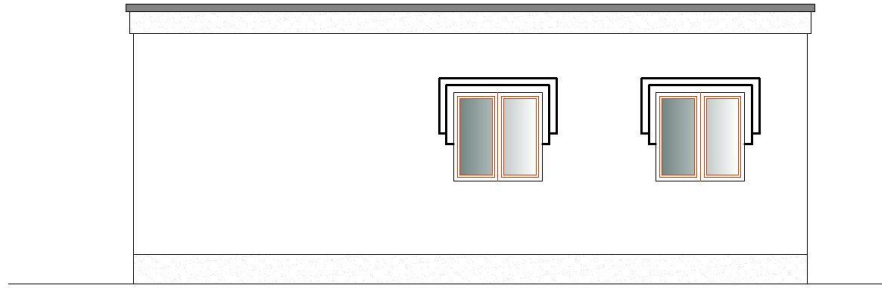

FACADE LATÉRALE GAUCHE

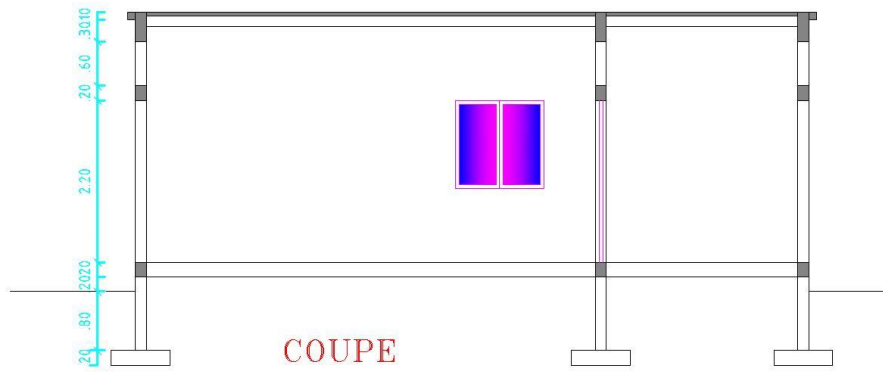

COUPE

VIVIER

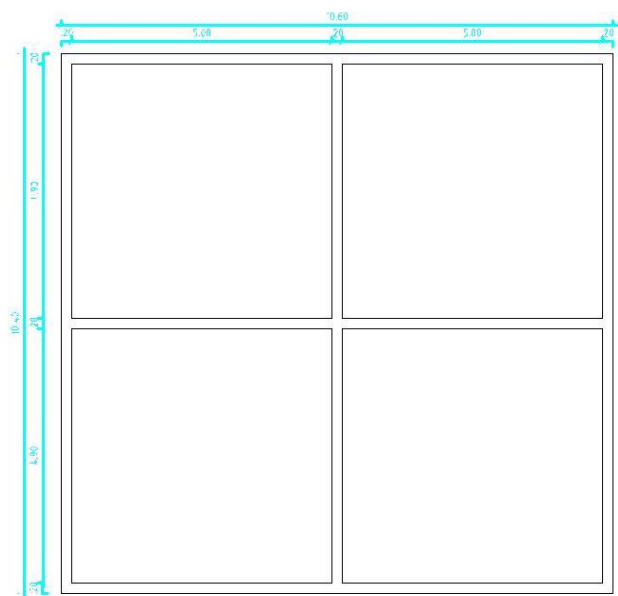

PLAN

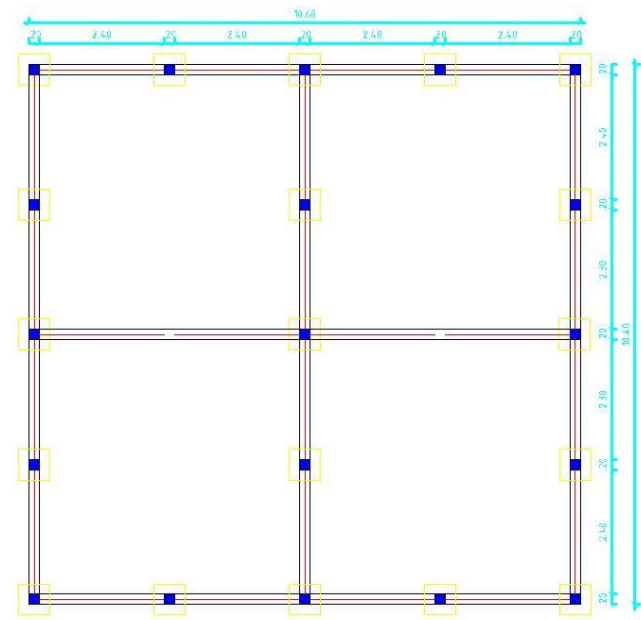

PONDATION

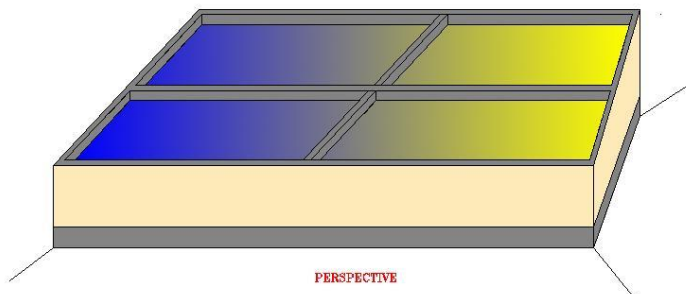

PERSPECTIVE

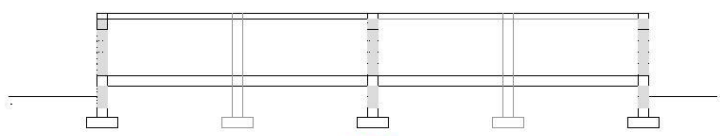

COUPE

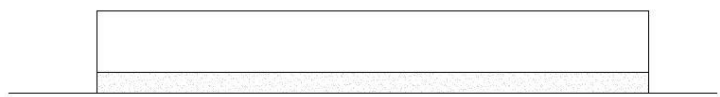

FACADE PRINCIPALE

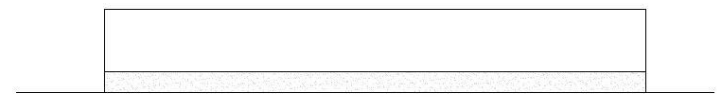

FACADE LATÉRALE

BASSIN PISCICOLE

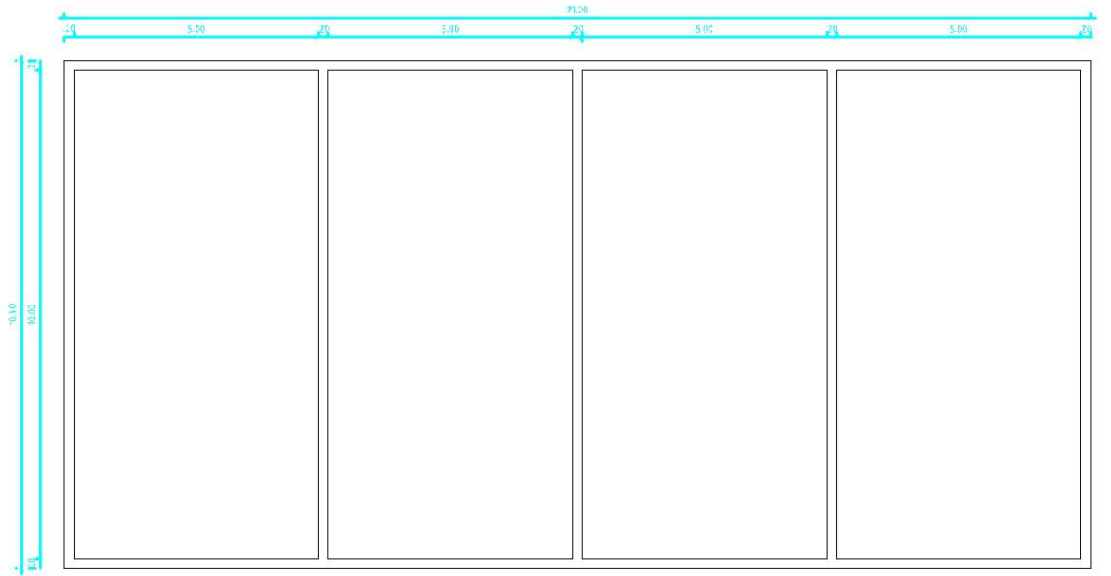

PLAN

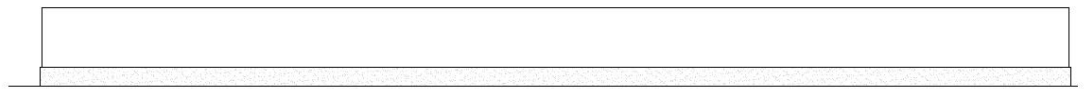

FACADE PRINCIPALE

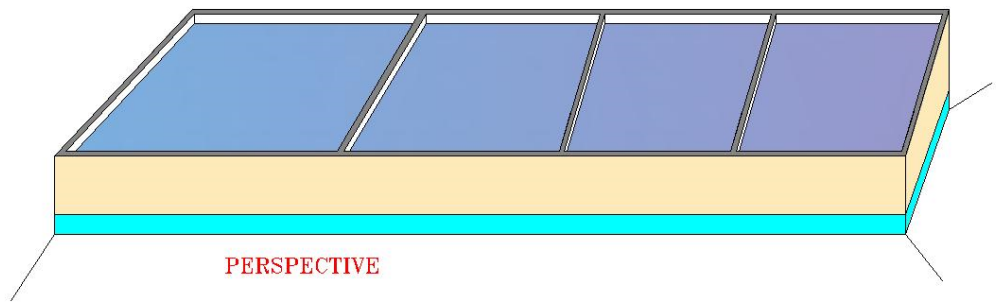

PERSPECTIVE

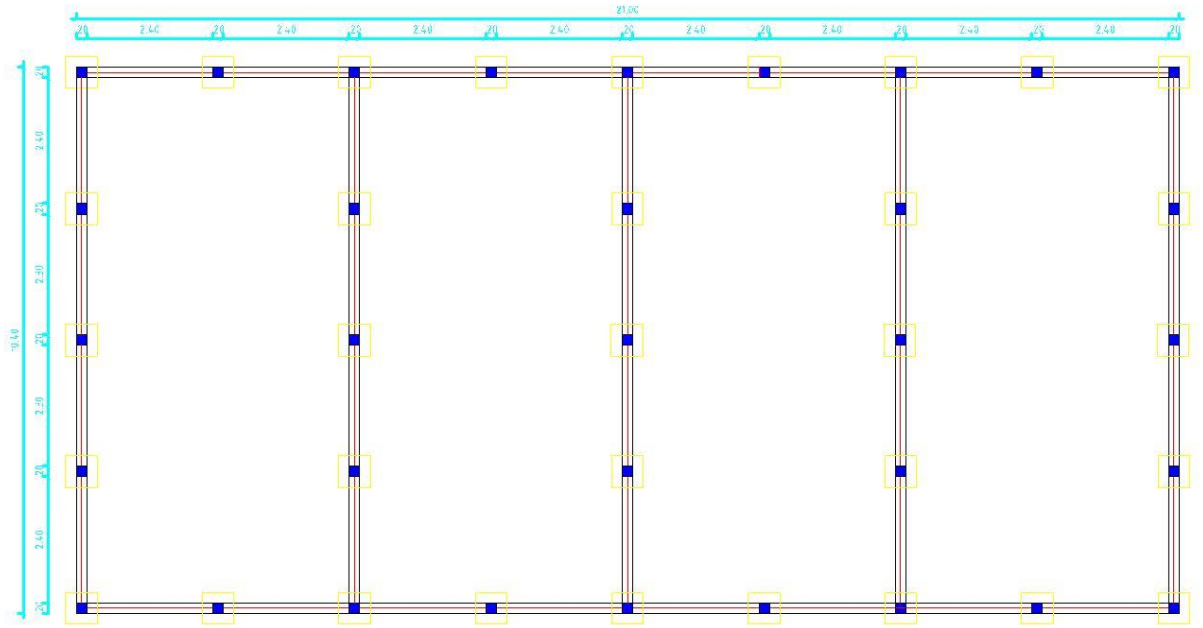

FONDATION

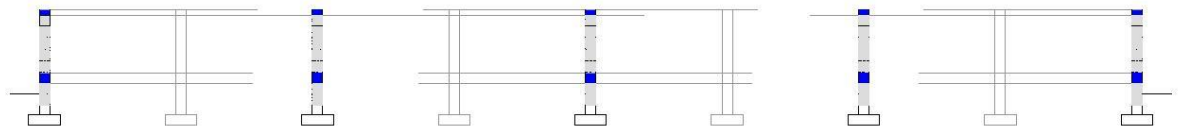

COUPE

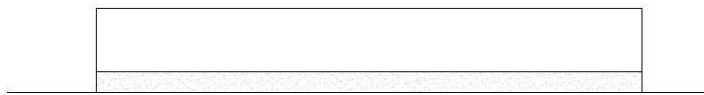

FACADE LATÉRALE

MAGASIN DE STOCKAGE

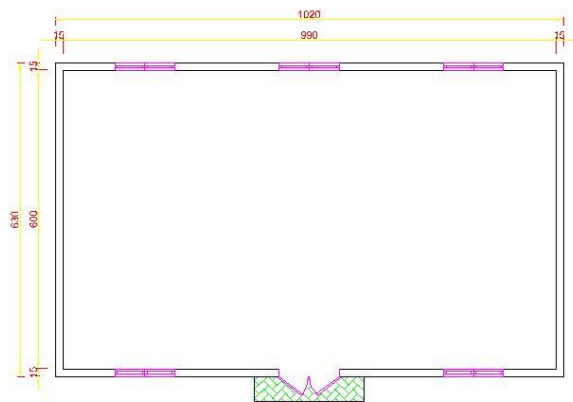

PLAN

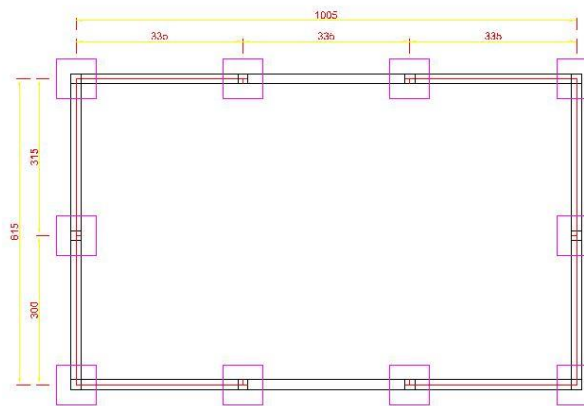

FONDATION

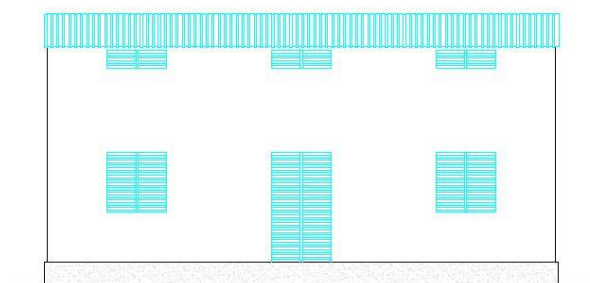

FACADE PRINCIPALE

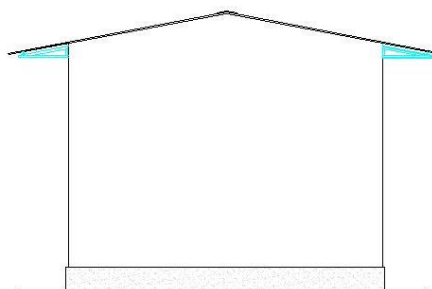

FACADE LATERALE

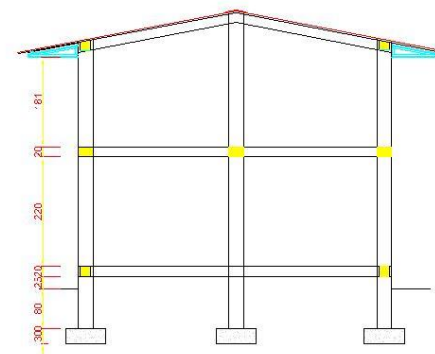

COUPE

CHATEAU D'EAU

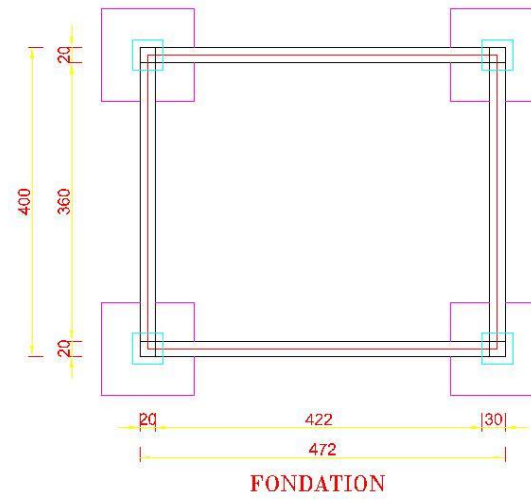
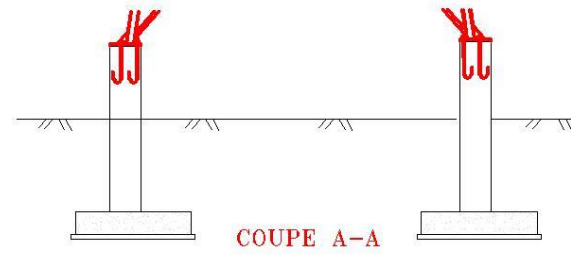
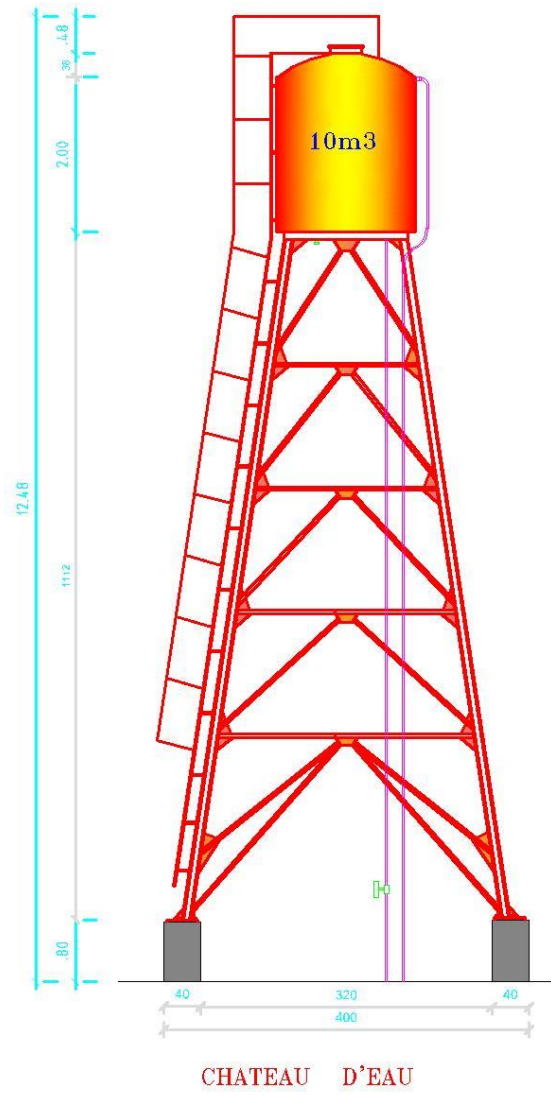

BLOC DE TOILETTE

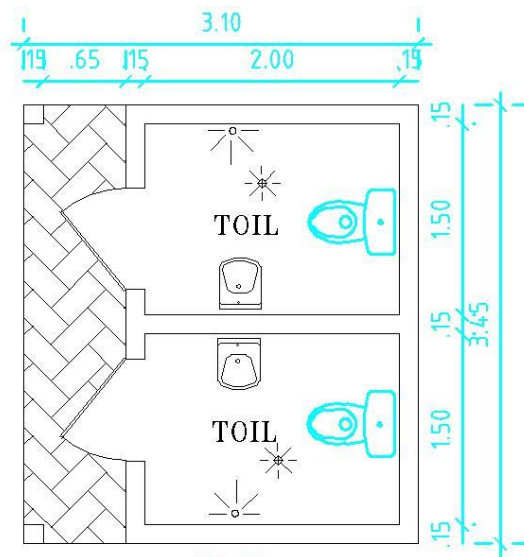

PLAN

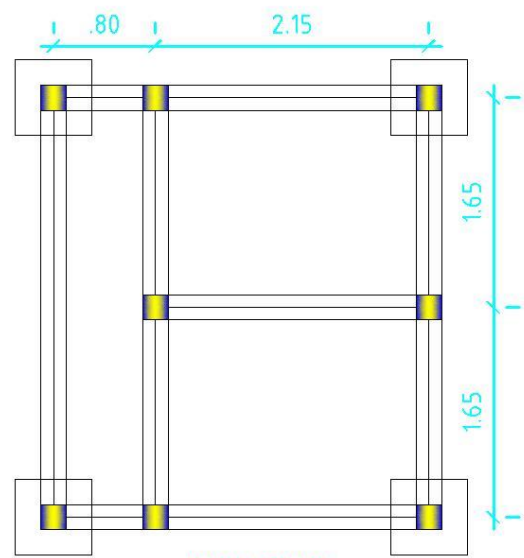

FONDATION

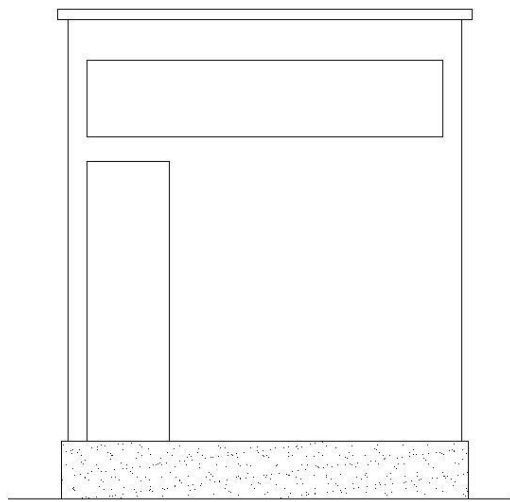

FACADE LATERALE

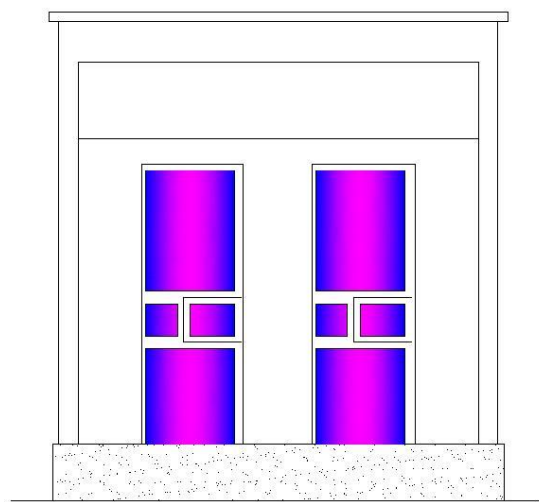

FACADE PRINCIPALE

FOSSE SEPTIQUE

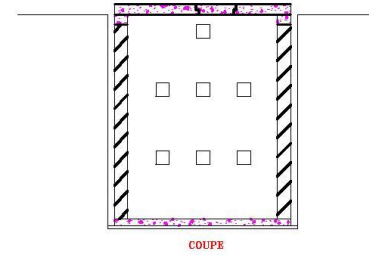
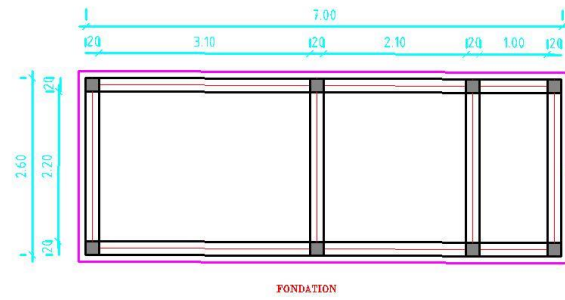
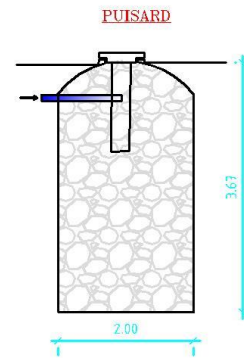
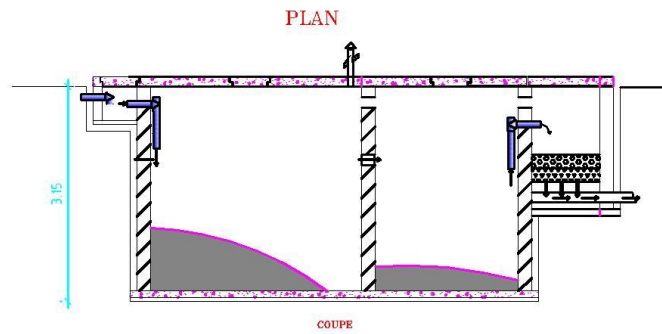
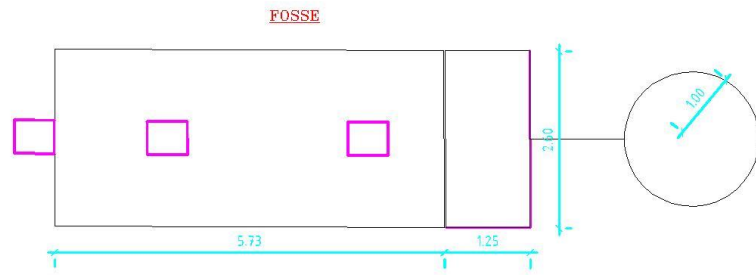

LOGEMENT DU GARDIEN

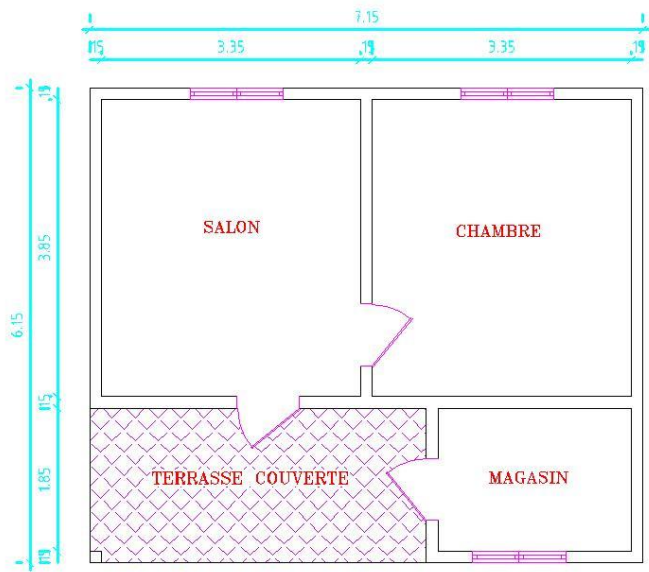

PLAN

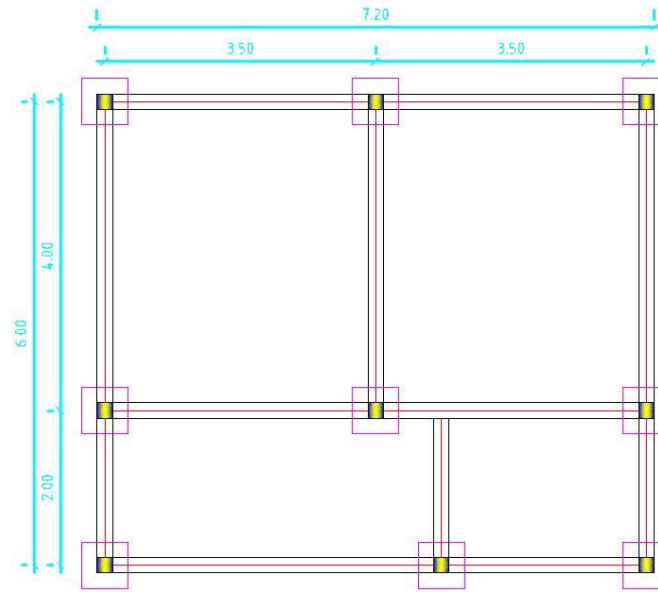

FONDATION

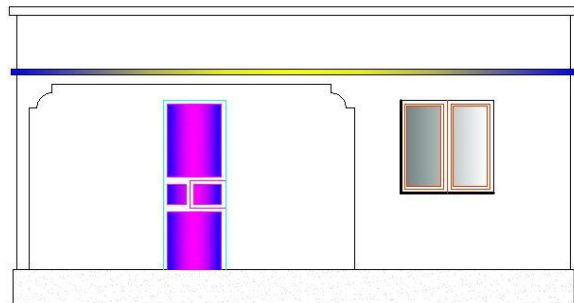

FACADE PRINCIPALE

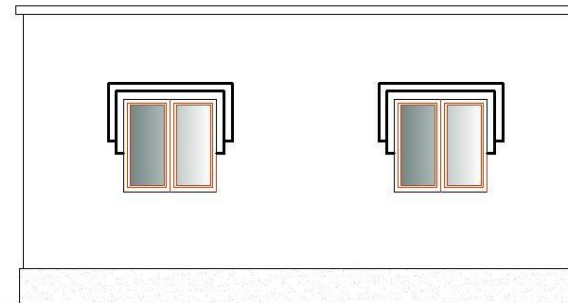

FACADE POSTERIEURE

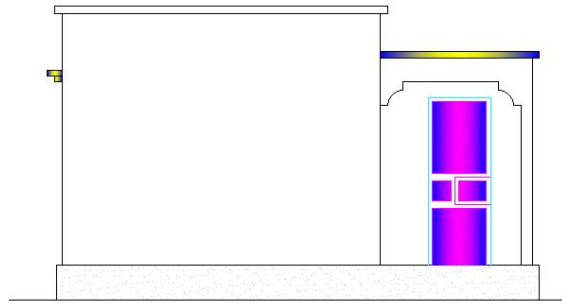

FACADE LATÉRALE DROITE

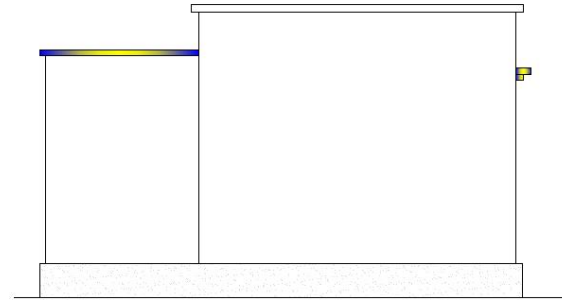

FACADE LATÉRALE DROITE

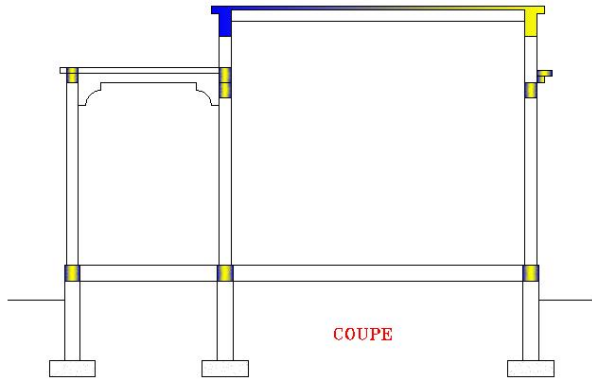

COUPE

BLOC DE CUISINE EXTERIEURE

Cuisine exterieure / J17

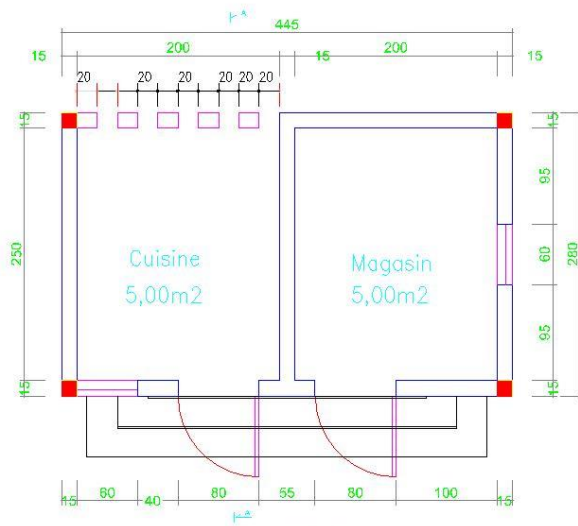

PLAN

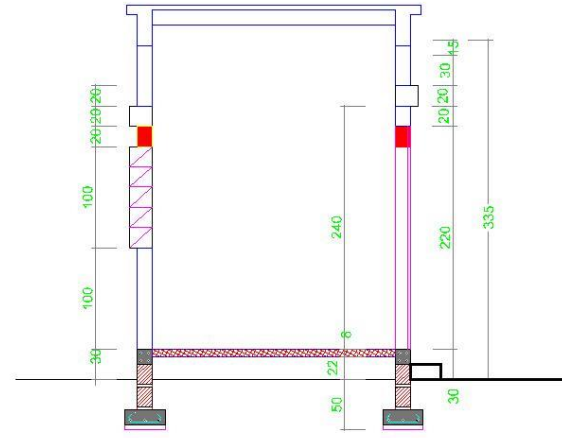

COUPE AA

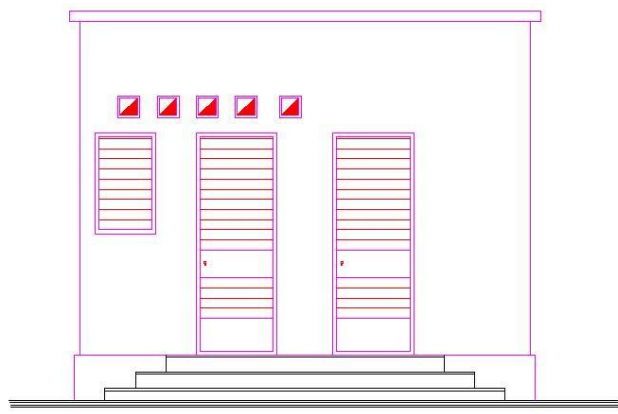

FAÇADE

CLOTURE

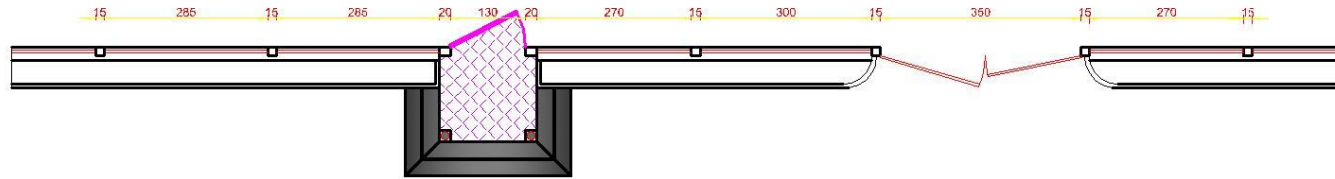

PLAN

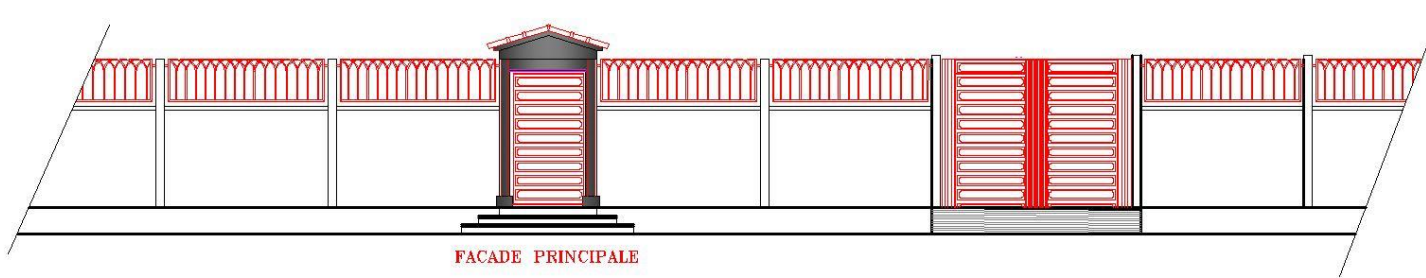

LOT III

PÉRIMÈTRE IRRIGUÉ DE 15HA A BENKADI

Fond topo
Plan d'aménagement
Profil en travers
Profil Long
Plans ouvrages

Fond topo

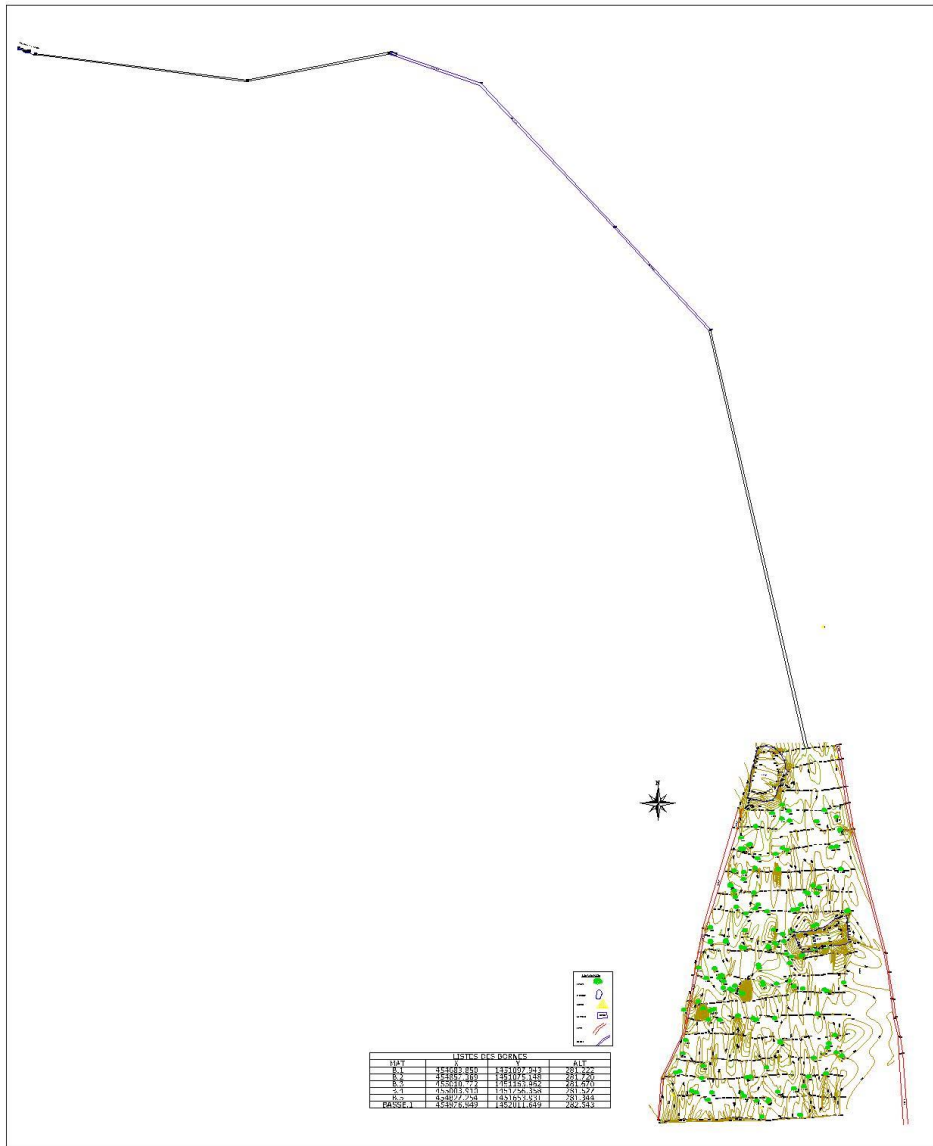

LISTE DES POINTS			
NO	X	Y	ALT
1	34387.000	132107.000	201.200
2	34387.000	132107.000	201.200
3	34387.000	132107.000	201.200
4	34387.000	132107.000	201.200
5	34387.000	132107.000	201.200
6	34387.000	132107.000	201.200
PASSE 1	34387.000	132107.000	201.200

Plan d'aménagement

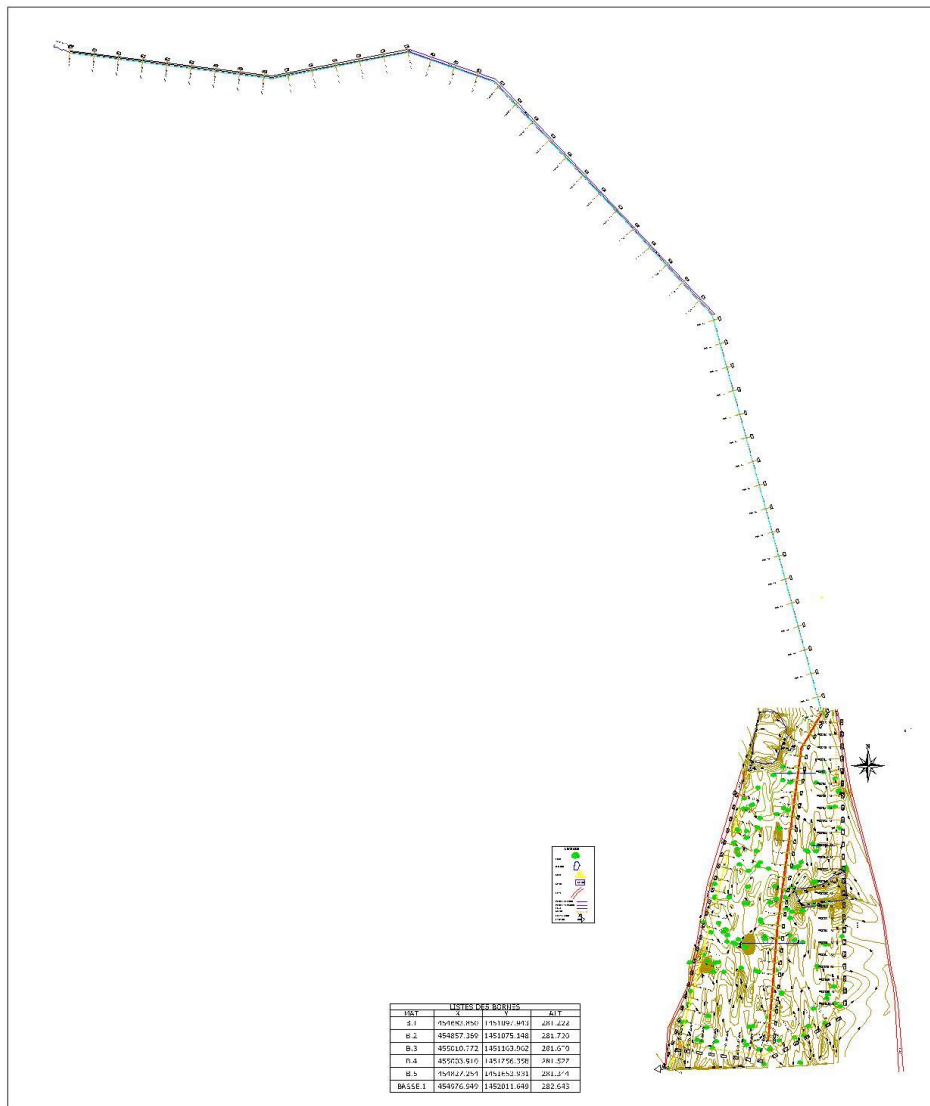

Profil en travers

Profil Long

Plans ouvrages

Plan type Ouvrage de prise double

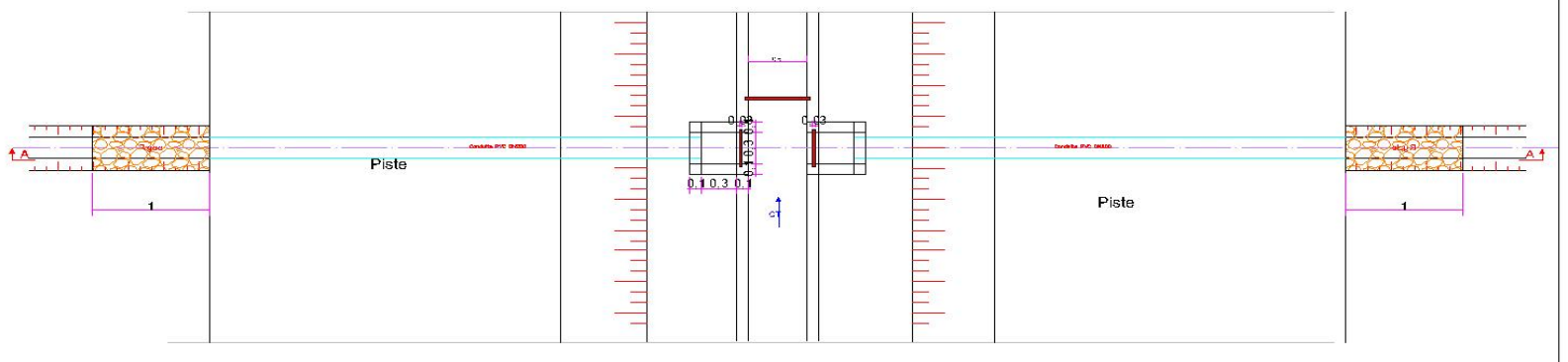
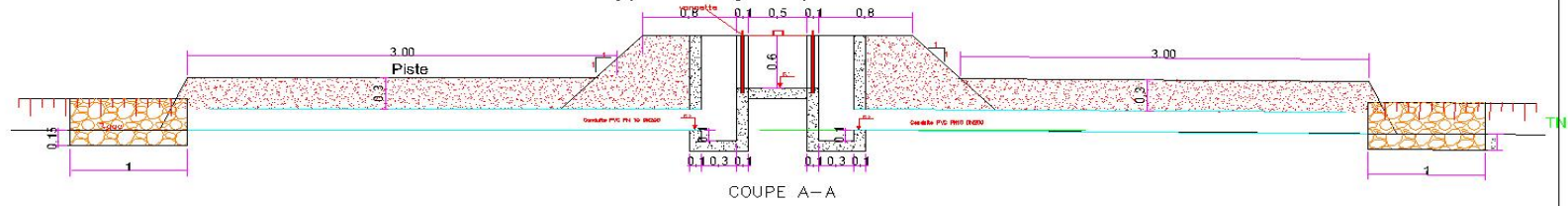

OUVRAGE DE DECHARGE

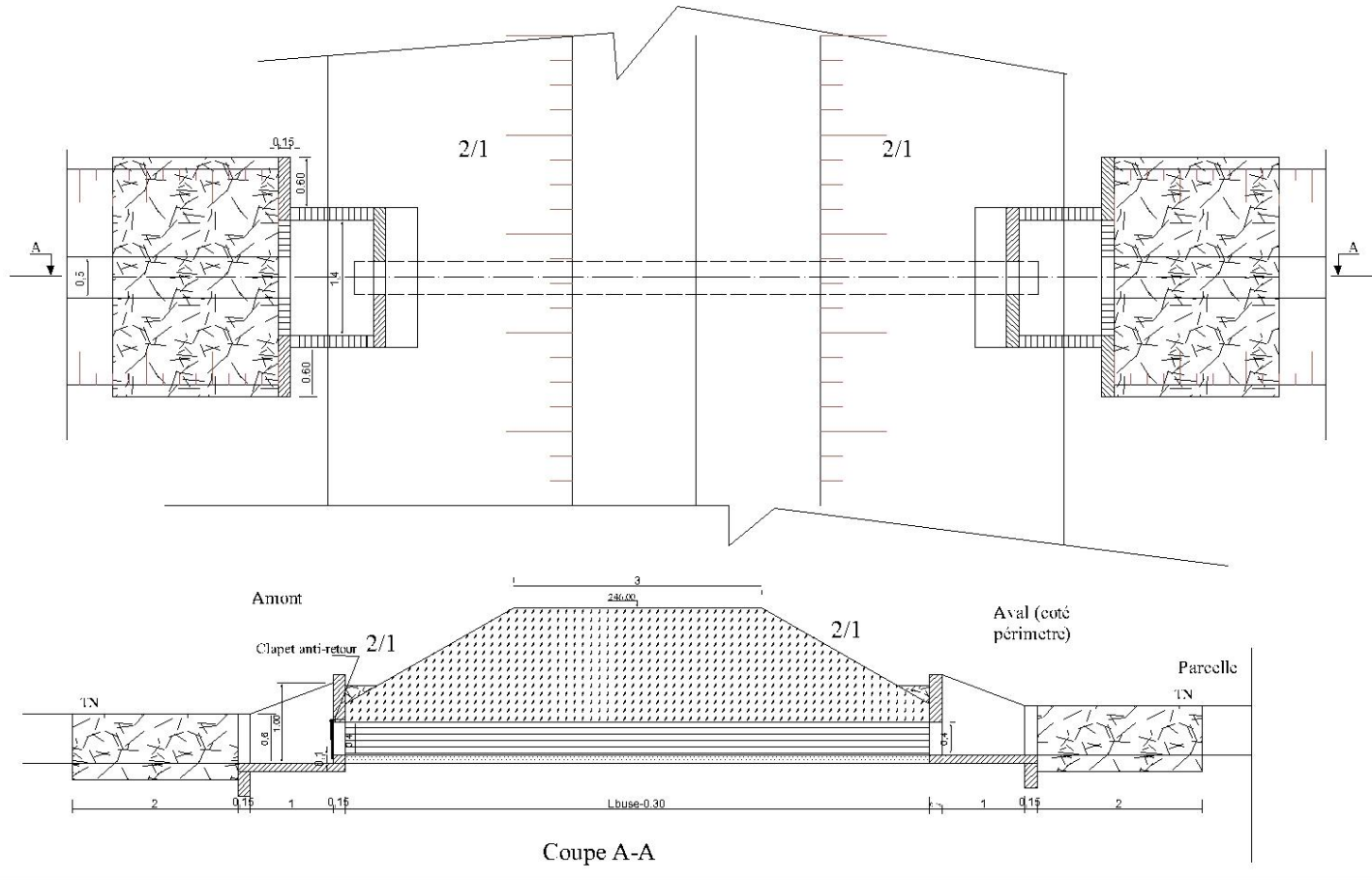

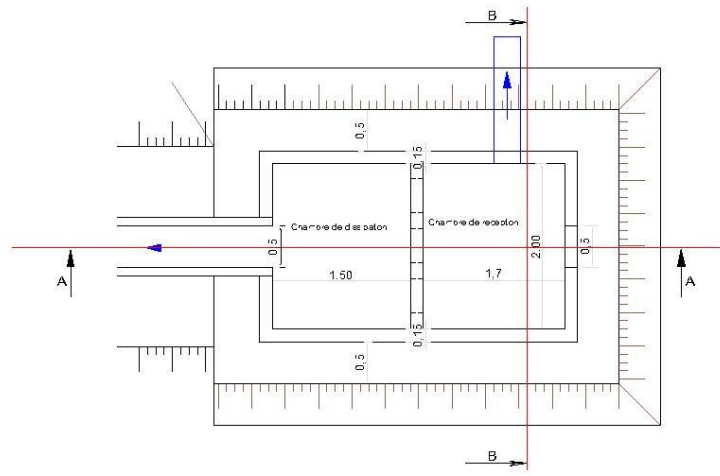

Vue en plan

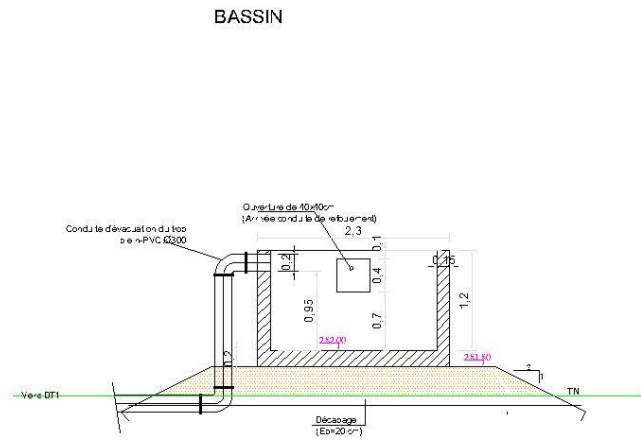

COUPE B-B

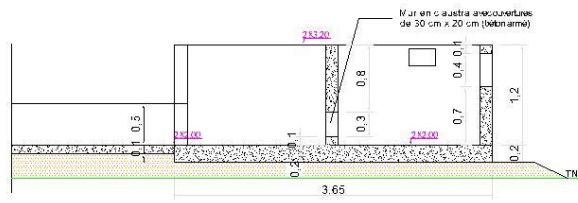

Coupe A-A

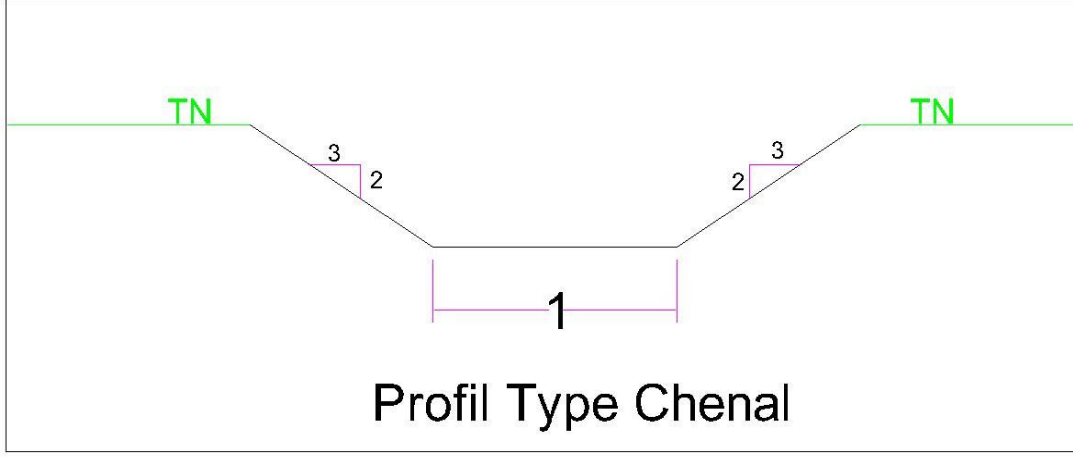
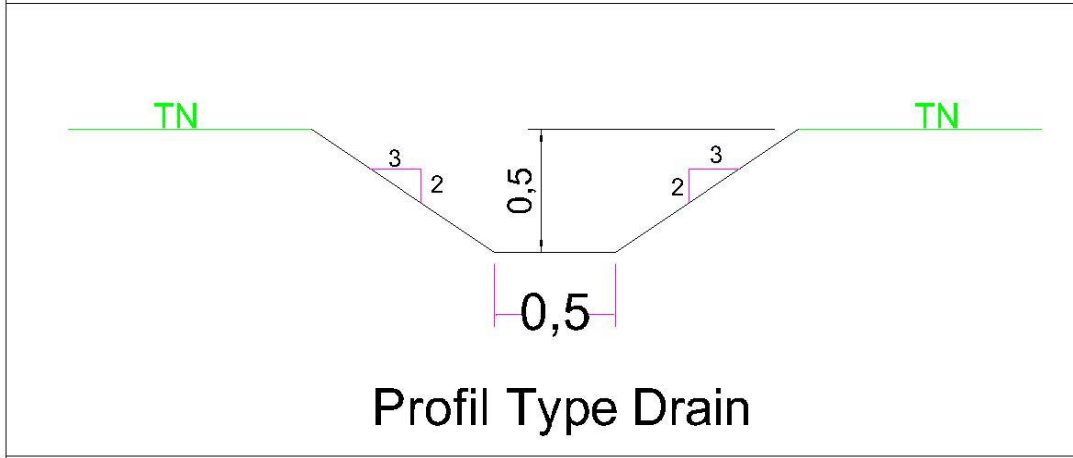
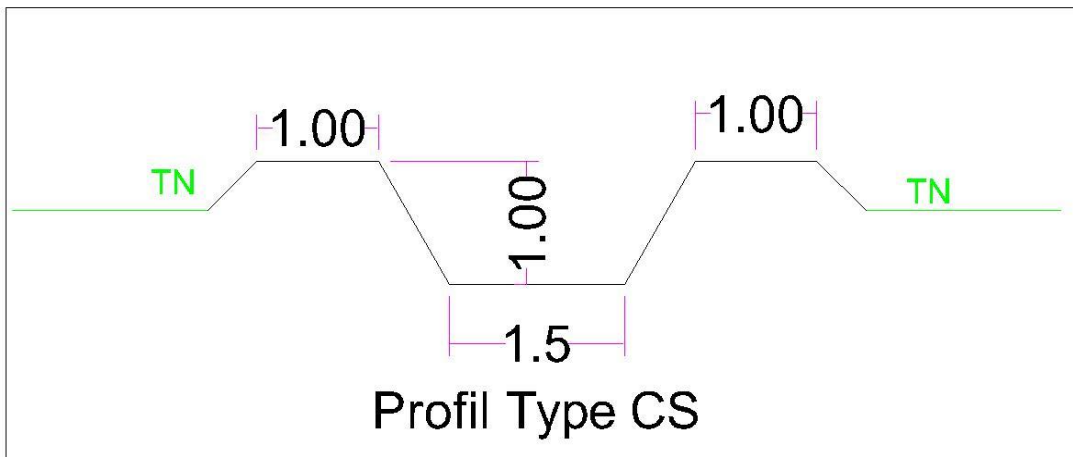

PÉRIMÈTRE IRRIGUÉ DE 15HA A PARA

Fond topo
Plan d'aménagement
Profil en travers
Profil Long
Plans ouvrages

Fond topo

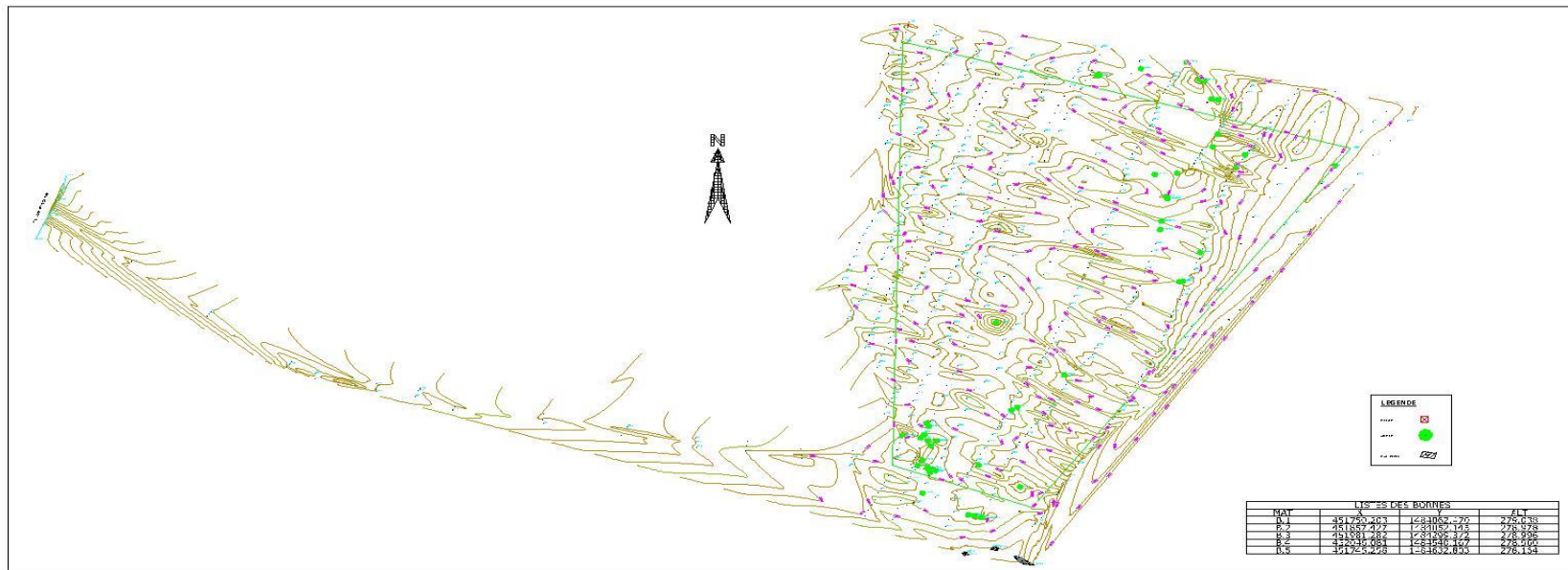

Plan d'aménagement

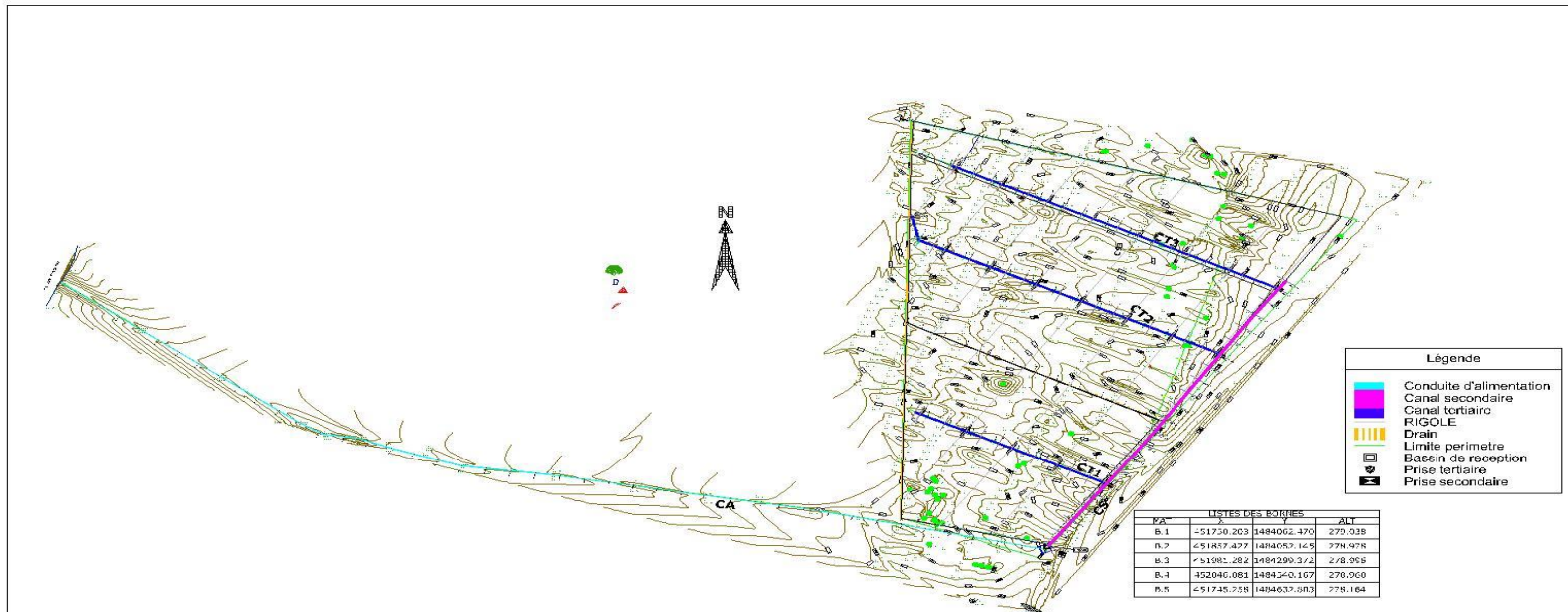

Profil en travers

Canaux Secondaires CS

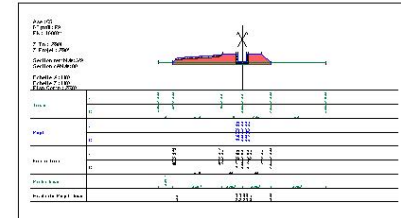
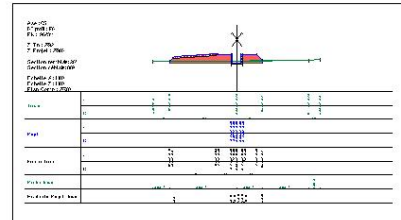
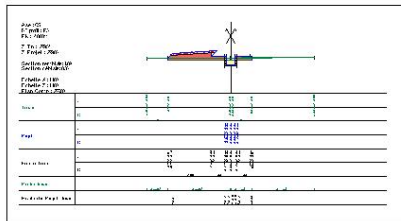
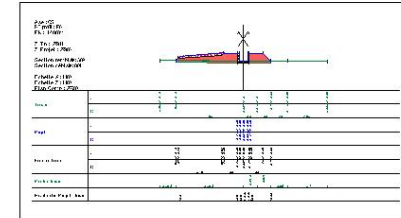
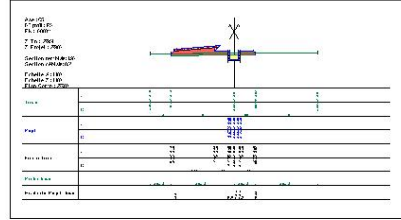
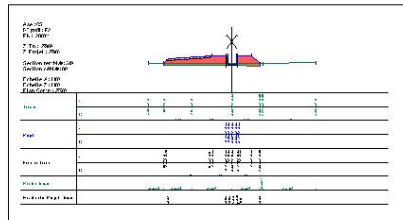
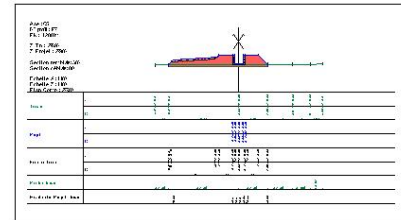
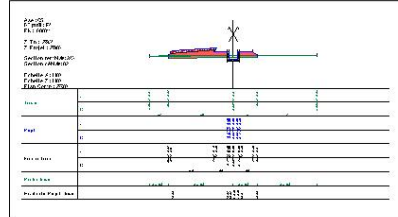
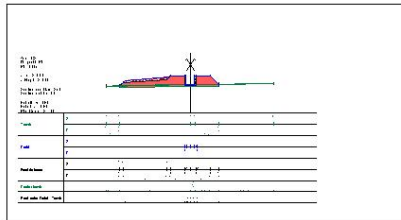

Profil Long

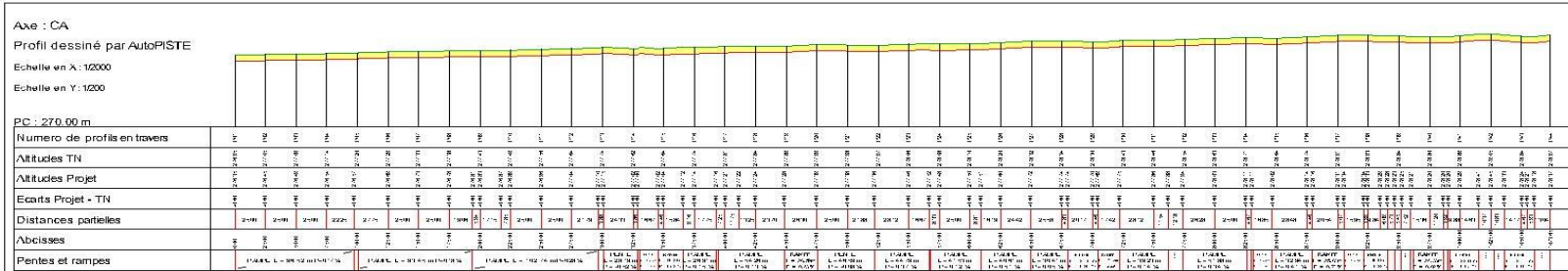

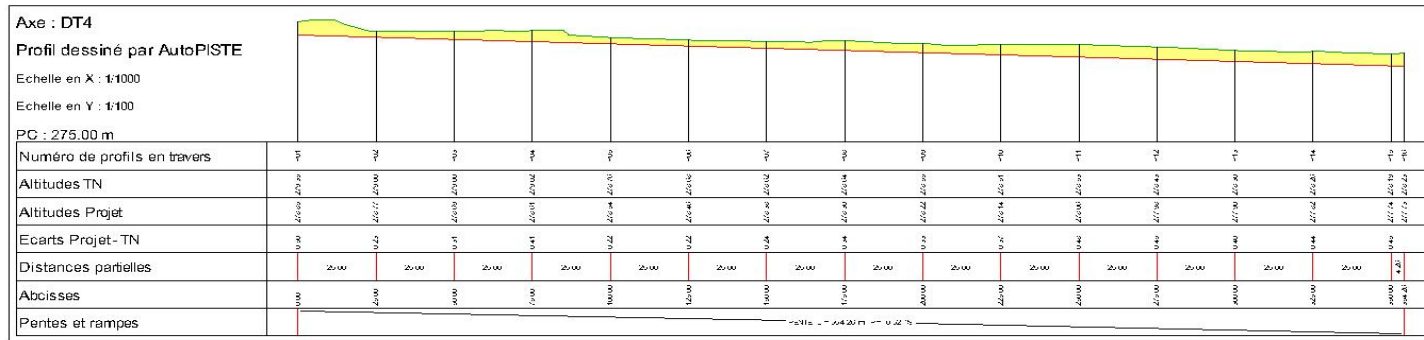
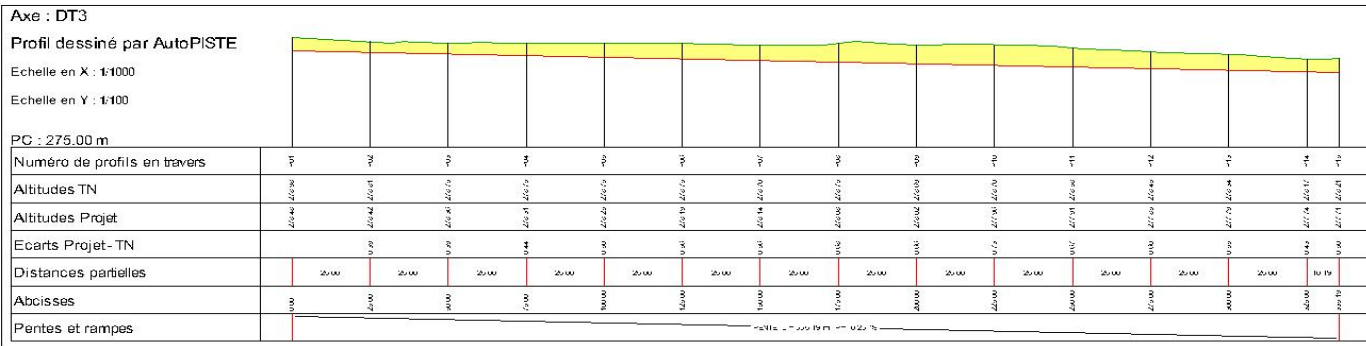
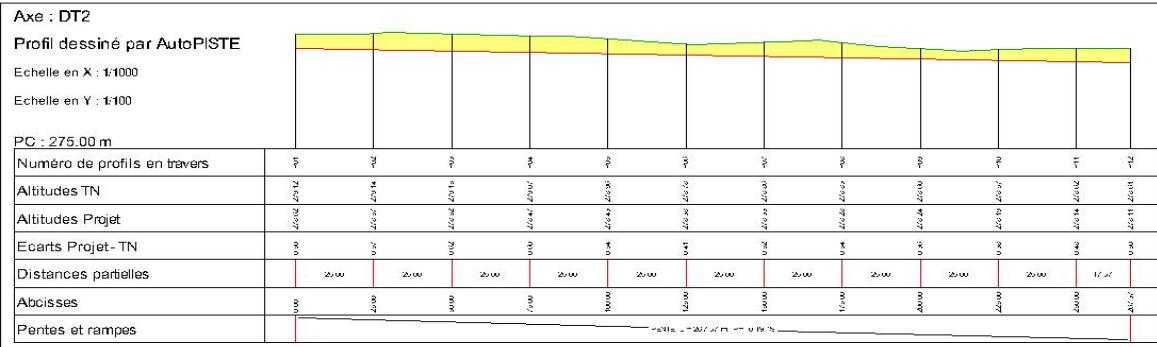

Plans ouvrages

Plan type Ouvrage de prise double

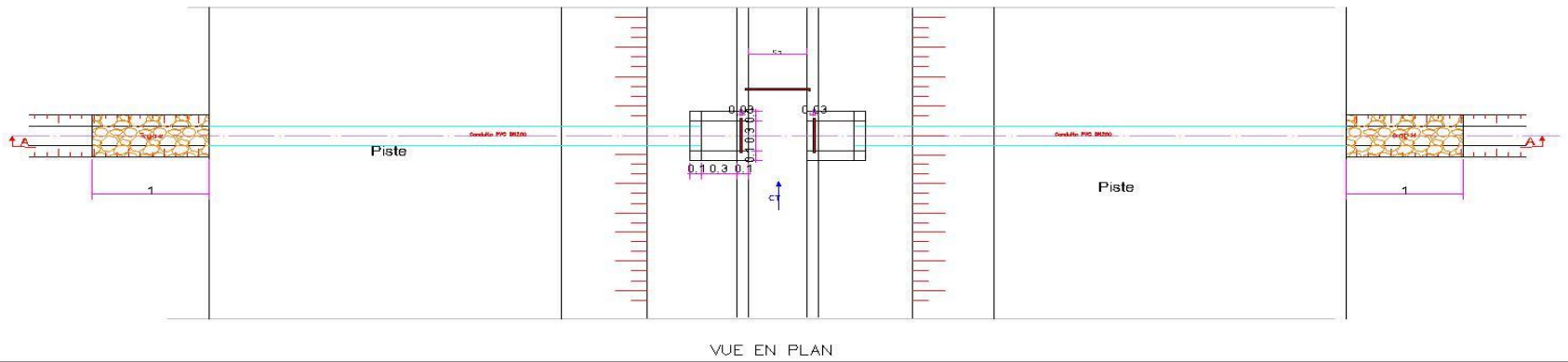
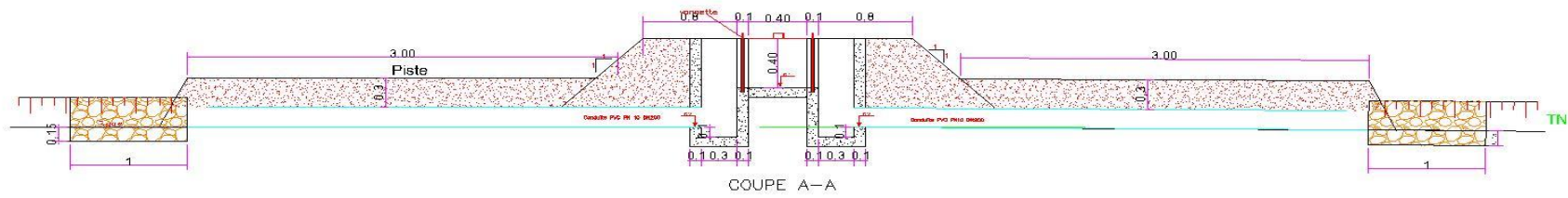

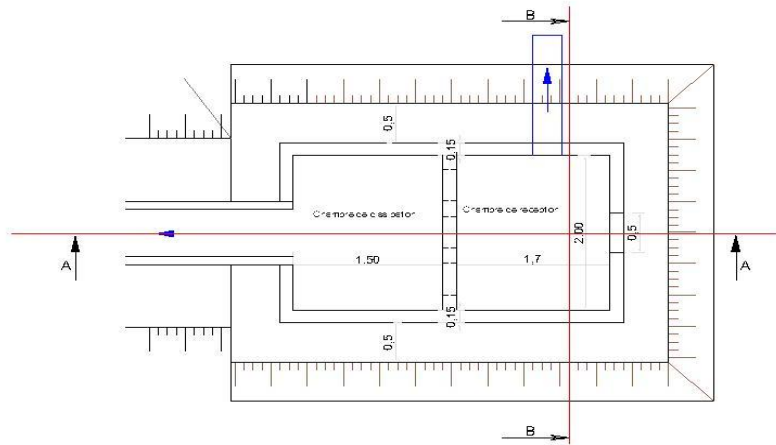

Vue en plan

Plan type Bassin de reception des eaux

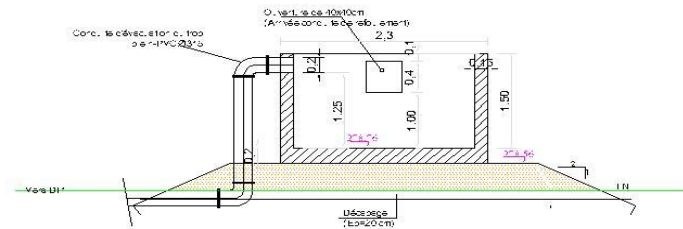

COUPE B-B

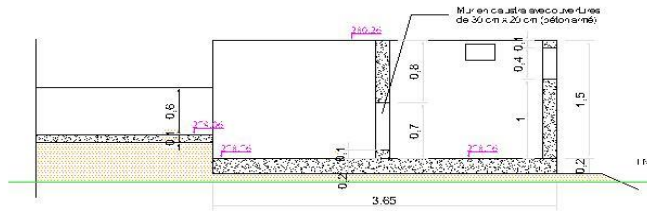

Coupe B-B

